

**Aero**

**LED System 2007-08**

*FUTURA  
LIGHTING*

# LDL - Series

Model: LDL-90

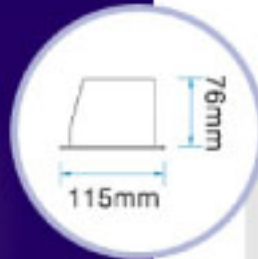

## Z-Power LED

Material: Diecast Aluminum / Steel Watt: 1.2W x 4(350mA)  
115x115, H:76mm

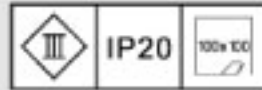

LED COLOR: WH W/W

COLOR: WH BK SY

Z-Power LED 1.2Wx4 57°

H(m)	θ(Lx)	2x24°	D(m)
1m	50		1.09
2m	13		2.17
3m	6		3.26
4m	3		4.34

Model: LDL-91

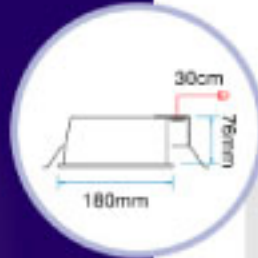

## Z-Power LED

Material: Diecast Aluminum / Steel Watt: 1.2W x 6(350mA)  
90x180, H:80mm

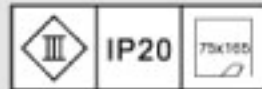

LED COLOR: WH W/W

COLOR: WH BK SY

Z-Power LED 1.2Wx6 45°

H(m)	θ(Lx)	2x24°	D(m)
1m	30		0.99
2m	20		1.78
3m	9		2.67
4m	6		3.56

Model: LDL-92



## Z-Power LED

Material: Diecast Aluminum / Steel Watt: 1.2W x 8(350mA)  
145x145, H:80mm

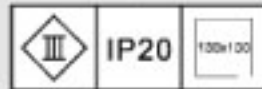

LED COLOR: WH W/W

COLOR: WH BK SY

Z-Power LED 1.2Wx8 60°

H(m)	θ(Lx)	2x24°	D(m)
1m	37		1.15
2m	24		2.31
3m	11		3.48
4m	8		4.62

Model: LDL-93

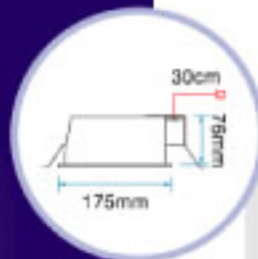

## Z-Power LED

Material: Diecast Aluminum / Steel Watt: 1.2W x 12(350mA)  
175x175, H:80mm

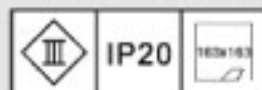

LED COLOR: WH W/W

COLOR: WH BK SY

Z-Power LED 1.2Wx12 58°

H(m)	θ(Lx)	2x24°	D(m)
1m	44		1.11
2m	41		2.22
3m	18		3.33
4m	15		4.43

Model: LDL-94

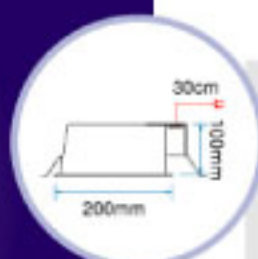

## Z-Power LED

Material: Diecast Aluminum / Steel Watt: 1.2W x 18(350mA)  
200x200, H:80mm

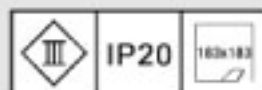

LED COLOR: WH W/W

COLOR: WH BK SY

Z-Power LED 1.2Wx18 50°

H(m)	θ(Lx)	2x24°	D(m)
1m	225		0.93
2m	96		1.87
3m	25		2.80
4m	14		3.73



### Z-Power LED

Material: Diecast / Aluminum      Watt: 1.2W(350mA)  
 ø90, H:42mm

 LED COLOR: WH RD BL GN AM      COLOR: AB

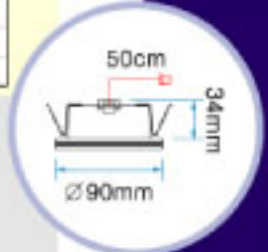

Z-Power 1.2W 91°			
H(m)	E(Lx)	2x45°	D(m)
1m	2		2.04
2m	0.8		4.07
3m	0.3		6.11



Model: LDL-905A

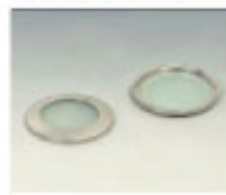

### LDC-905A ACCESSORIES

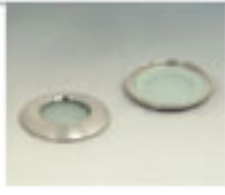
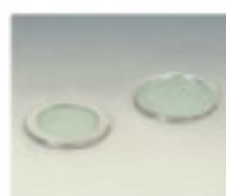
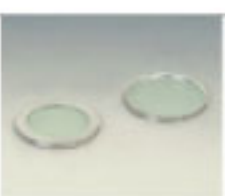
	<b>DC-AC51</b> Ø90, H:9M		<b>DC-AC52</b> Ø90, H:20M
	<b>DC-AC53</b> Ø90, H:20M		<b>DC-AC54</b> Ø90, H:10M
	<b>DC-AC55</b> Ø90, H:15M		<b>DC-AC56</b> Ø90, H:8M



IP64

### Z-Power LED

Material: Diecast / Aluminum      Watt: 1.2W(350mA)  
 ø100, H:82mm

 LED COLOR: WH RD BL GN AM      COLOR: FR

Z-Power 1.2W 106°			
H(m)	E(Lx)	2x63°	D(m)
1m	2		2.65
2m	0.5		5.31
3m	0.2		7.96

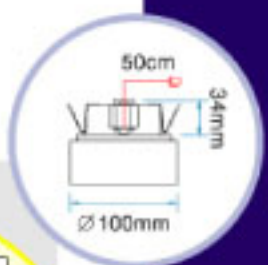

Model: LDL-905A1



### LDC-905A1 ACCESSORIES

	<b>DC-AC60</b> Ø100, H:46M		<b>DC-AC61</b> 100X100, H:46M
	<b>DC-AC63</b> Ø150, H:46M		<b>DC-AC64</b> 150X150, H:46M

# LDL - Series

Model: LDL-F01-12

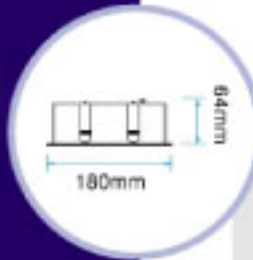

## PLCC Top LED

Material: Aluminum    Watt: 0.06W x 12(20mA 24V)  
180x57, H:66mm

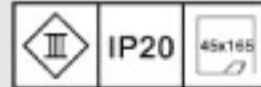

LED COLOR:



COLOR:

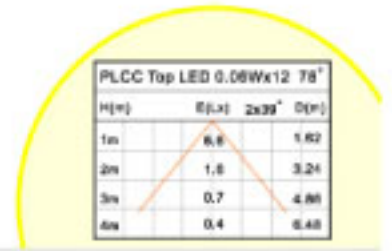

Model: LDL-F01-18

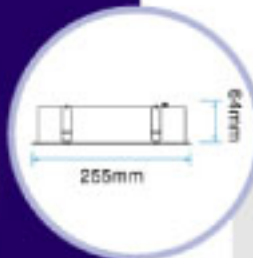

## PLCC Top LED

Material: Aluminum    Watt: 0.06W x 18(20mA 24V)  
255x57, H:66mm

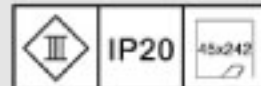

LED COLOR:



COLOR:



Model: LDL-F01-24

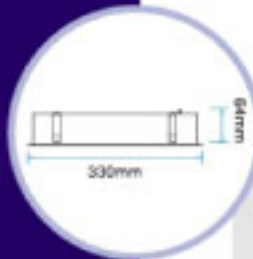

## PLCC Top LED

Material: Aluminum    Watt: 0.06W x 24(20mA 24V)  
330x57, H:66mm

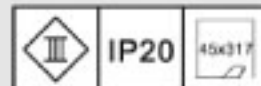

LED COLOR:



COLOR:



Model: LDL-G01-12

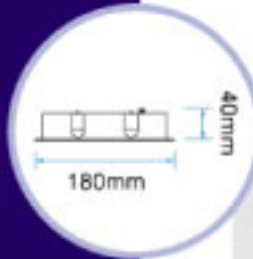

## PLCC Top LED

Material: Aluminum    Watt: 0.06W x 12(20mA 24V)  
180x57, H:42mm

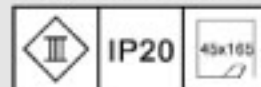

LED COLOR:



COLOR:





### PLCC Top LED

Material: Aluminum    Watt: 0.06W x 18(20mA 24V)  
 255x57, H:42mm



 LED COLOR: WH RD BL GN AM    COLOR: AB

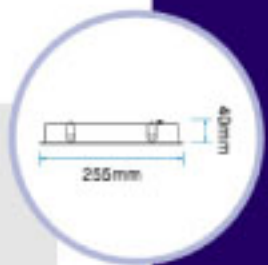

Model: LDL-G01-18



### PLCC Top LED

Material: Aluminum    Watt: 0.06W x 24(20mA 24V)  
 330x57, H:42mm



 LED COLOR: WH RD BL GN AM    COLOR: AB

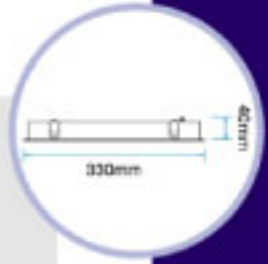

Model: LDL-G01-24



### PLCC TOP LED



 LED COLOR: WH RD BL GN AM    COLOR: AB



**LDL-G01-32**  
 Material: Aluminum  
 620x57, H:42mm  
 WATT: 0.06Wx32 (20mA 24V)



**LDL-G01-78**  
 Material: Aluminum  
 990x57, H:42mm  
 WATT: 0.06Wx78 (20mA 24V)



**LDL-G01-120**  
 Material: Aluminum  
 1508x57, H:42mm  
 WATT: 0.06Wx120 (20mA 24V)

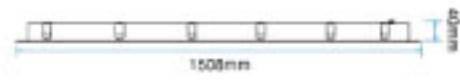

**LDL-G01-162**  
 Material: Aluminum  
 2026x57, H:42mm  
 WATT: 0.06Wx162 (20mA 24V)



**LDL-G01-240**  
 Material: Aluminum  
 2988x57, H:42mm  
 WATT: 0.06Wx240 (20mA 24V)



## *LDC series*





# LDC - Series

LDC series

Model: LDC-003

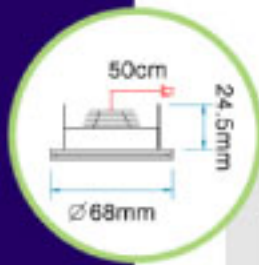

## Luxeon LED

Material: Aluminum  
ø68, H:30mm

Watt: 1W x 3(350mA)

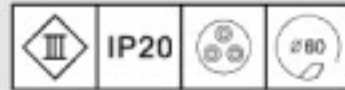

LED COLOR: WH RD BL GN AM W/W

COLOR: FR

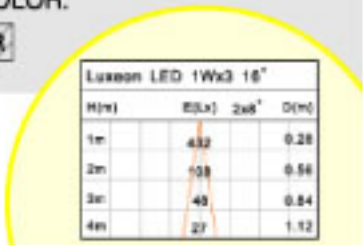

Model: LDC-003A

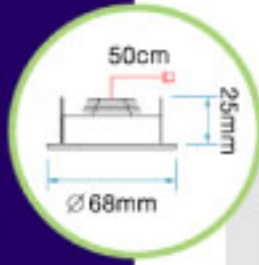

## Luxeon LED

Material: Aluminum  
ø68, H:27.5mm

Watt: 1W x 3(350mA)



LED COLOR: WH RD BL GN AM W/W

COLOR: FR

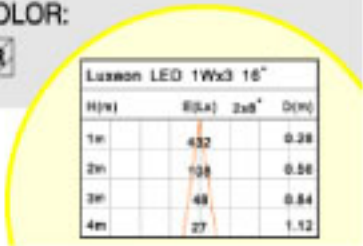

Model: LDC-003D

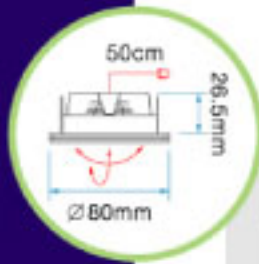

## Luxeon LED

Material: Aluminum  
ø80, H:32mm

Watt: 1W x 3(350mA)

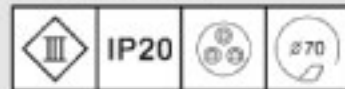

LED COLOR: WH RD BL GN AM W/W

COLOR: FR

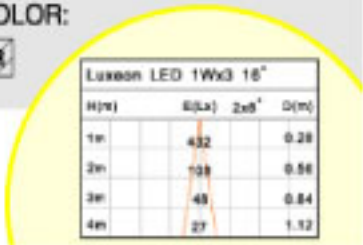

Model: LDC-003AD

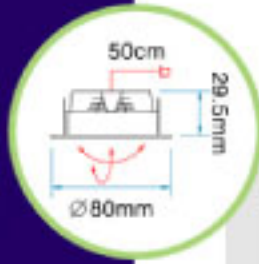

## Luxeon LED

Material: Aluminum  
ø80, H:32mm

Watt: 1W x 3(350mA)

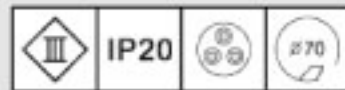

LED COLOR: WH RD BL GN AM W/W

COLOR: FR

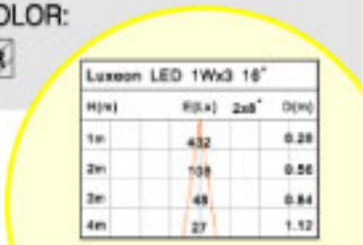

### Luxeon LED

Material: Aluminum    Watt: 1W x 6(350mA)  
 ø105, H:31mm



LED COLOR: WH RD BL GN AM W/W    COLOR: FR

H(m)	E(Lx)	2xθ°	θ(m)
1m	903		0.26
2m	226		0.53
3m	103		0.79
4m	58		1.05

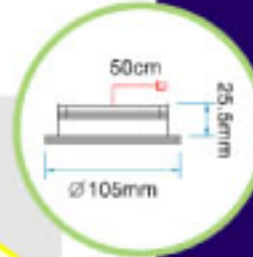

Model: LDC-006



### Luxeon LED

Material: Aluminum    Watt: 1W x 6(350mA)  
 ø105, H:31mm

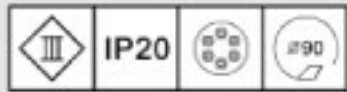

LED COLOR: WH RD BL GN AM W/W    COLOR: FR

H(m)	E(Lx)	2xθ°	θ(m)
1m	903		0.26
2m	226		0.53
3m	103		0.79
4m	58		1.05

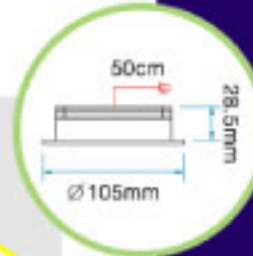

Model: LDC-006A



### Luxeon LED

Material: Aluminum    Watt: 1W x 6(350mA)  
 ø120, H:40.5mm



LED COLOR: WH RD BL GN AM W/W    COLOR: FR

H(m)	E(Lx)	2xθ°	θ(m)
1m	903		0.26
2m	226		0.53
3m	103		0.79
4m	58		1.05

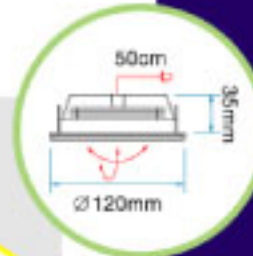

Model: LDC-006D



### Luxeon LED

Material: Aluminum    Watt: 1W x 6(350mA)  
 ø120, H:40.5mm



LED COLOR: WH RD BL GN AM W/W    COLOR: FR

H(m)	E(Lx)	2xθ°	θ(m)
1m	903		0.26
2m	226		0.53
3m	103		0.79
4m	58		1.05

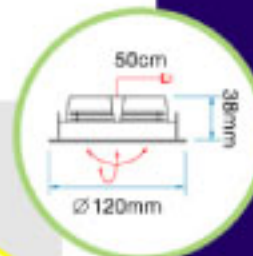

Model: LDC-006AD





# LDC - Series

LDC series

Model: LDC-015



## Luxeon LED

Material: Aluminum  
ø120, H:41mm

Watt: 1W x 15(350mA)

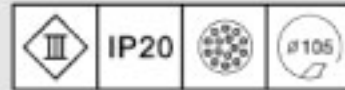

LED COLOR:  
WH RD BL GN AM W/W

COLOR:  
FR

H(m)	ILL(Lx)	2xθ°	D(m)
1m	2793	0.26	
2m	699	0.53	
3m	310	0.79	
4m	175	1.05	

Model: LDC-015A

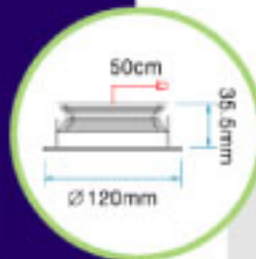

## Luxeon LED

Material: Aluminum  
ø120, H:41mm

Watt: 1W x 15(350mA)



LED COLOR:  
WH RD BL GN AM W/W

COLOR:  
FR

H(m)	ILL(Lx)	2xθ°	D(m)
1m	2793	0.26	
2m	699	0.53	
3m	310	0.79	
4m	175	1.05	

Model: LDC-015D

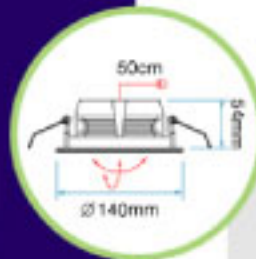

## Luxeon LED

Material: Aluminum  
ø140, H:59.5mm

Watt: 1W x 15(350mA)

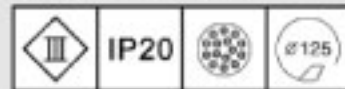

LED COLOR:  
WH RD BL GN AM W/W

COLOR:  
FR

H(m)	ILL(Lx)	2xθ°	D(m)
1m	2793	0.26	
2m	699	0.53	
3m	310	0.79	
4m	175	1.05	

Model: LDC-015AD

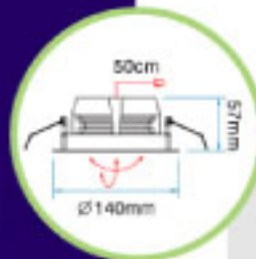

## Luxeon LED

Material: Aluminum  
ø140, H:59.5mm

Watt: 1W x 15(350mA)

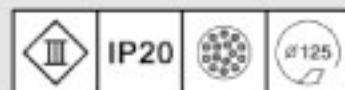

LED COLOR:  
WH RD BL GN AM W/W

COLOR:  
FR

H(m)	ILL(Lx)	2xθ°	D(m)
1m	2793	0.26	
2m	699	0.53	
3m	310	0.79	
4m	175	1.05	

### Z-Power LED

Material: Diecast Aluminum    Watt: 1.2W(350mA)  
 ø42, H:19.6mm



 LED COLOR:  WH  RD  BL  GN  AM    COLOR:  AB

H(m)	ELx)	D(m)
1m	24	0.90
2m	6	1.80
3m	3	2.80
4m	2	3.70



Model: LDC-101



### Z-Power LED

Material: Aluminum    Watt: 1.2W(350mA)  
 ø52, H:18.6mm



 LED COLOR:  WH  RD  BL  GN  AM    COLOR:  AB

H(m)	ELx)	D(m)
1m	24	0.90
2m	6	1.80
3m	3	2.80
4m	2	3.70



Model: LDC-101D



### Z-Power LED

Material: Diecast Aluminum    Watt: 1.2W(350mA)  
 ø42, H:31mm



 LED COLOR:  WH  RD  BL  GN  AM    COLOR:  AB

H(m)	ELx)	D(m)
1m	24	0.90
2m	6	1.80
3m	3	2.80
4m	2	3.70



Model: LDC-101-1



### Z-Power LED

Material: Aluminum    Watt: 1.2W(350mA)  
 ø52, H:28.9mm



 LED COLOR:  WH  RD  BL  GN  AM    COLOR:  AB

H(m)	ELx)	D(m)
1m	24	0.90
2m	6	1.80
3m	3	2.80
4m	2	3.70



Model: LDC-101D-1





# LDC - Series,

LDC series

Model: LDC-101-2

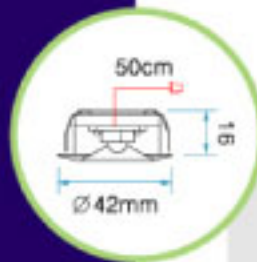

## Z-Power LED

Material: Diecast Aluminum Watt: 1.2W(350mA)  
 ø42, H:18.3mm

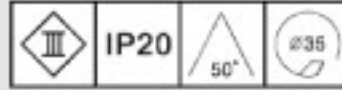

LED COLOR: | COLOR:  
 WH RD BL GN AM | AS

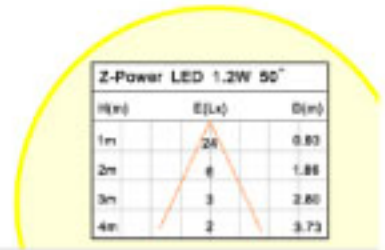

Model: LDC-101D-2

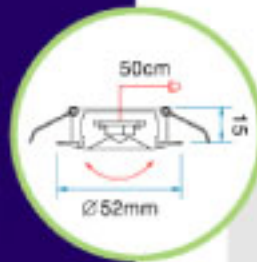

## Z-Power LED

Material: Aluminum Watt: 1.2W(350mA)  
 ø52, H:18mm

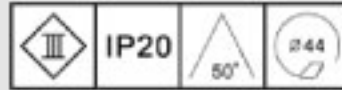

LED COLOR: | COLOR:  
 WH RD BL GN AM | AS

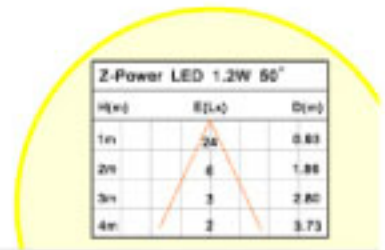

Model: LDC-101P



## Luxeon LED

Material: Aluminum Watt: 1W(350mA)  
 ø42, H:22.6mm

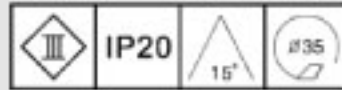

LED COLOR: | COLOR:  
 WH W/W RD BL GN AM | AS

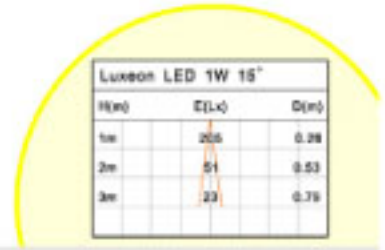

Model: LDC-101DP



## Luxeon LED

Material: Aluminum Watt: 1W (350mA)  
 ø52, H:20mm

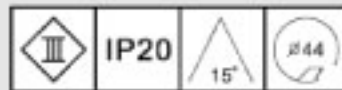

LED COLOR: | COLOR:  
 WH W/W RD BL GN AM | AS

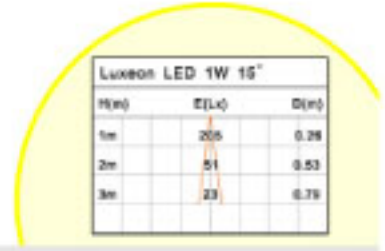



## Classification & Degree of protection



Class I luminaires with earth conductor.



Class II luminaires



Class III luminaires



Protection degree offered by the fixture to the ingress of solids and liquids

### IP 64

- 0 No protection.
- 1 Protected against solid bodies over 50mm in diameter.
- 2 Protected against solid bodies over 12mm in diameter.
- 3 Protected against solid bodies over 2.5mm in diameter.
- 4 Protected against solid bodies over 1mm in diameter.
- 5 Protected against dust.
- 6 Fully protected against dust.

### IP 64

- 0 No protection.
- 1 Protected against drops of water falling vertically.
- 2 Protected against drops of water at a max. inclination of 15 degree.
- 3 Protected against drops of water at a max. Inclination of 60 degree.
- 4 Protected against splashes of water.
- 5 Protected against jets of water
- 6 Protected against waves.
- 7 Protected against immersion.
- 8 Protected against long term immersion.



### Luxeon LED

Material: Aluminum    Watt: 1W(350mA)  
 ø42, H:34mm



 LED COLOR: WH W/W RD BL GN AM | COLOR: AB

Luxeon LED 1W 15°		
H(m)	E(Lx)	D(m)
1m	205	0.28
2m	51	0.53
3m	23	0.79

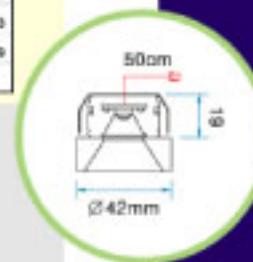

Model: LDC-101P-1



### Luxeon LED

Material: Aluminum    Watt: 1W(350mA)  
 ø52, H:30.3mm



 LED COLOR: WH W/W RD BL GN AM | COLOR: AB

Luxeon LED 1W 15°		
H(m)	E(Lx)	D(m)
1m	205	0.28
2m	51	0.53
3m	23	0.79



Model: LDC-101DP-1



### Luxeon LED

Material: Aluminum    Watt: 1W(350mA)  
 ø42, H:21.5mm



 LED COLOR: WH W/W RD BL GN AM | COLOR: AB

Luxeon LED 1W 15°		
H(m)	E(Lx)	D(m)
1m	205	0.28
2m	51	0.53
3m	23	0.79

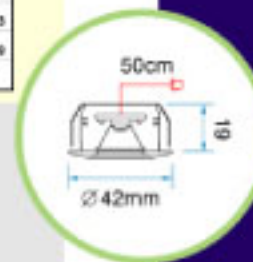

Model: LDC-101P-2



### Luxeon LED

Material: Aluminum    Watt: 1W(350mA)  
 ø52, H:21.1mm



 LED COLOR: WH W/W RD BL GN AM | COLOR: AB

Luxeon LED 1W 15°		
H(m)	E(Lx)	D(m)
1m	205	0.28
2m	51	0.53
3m	23	0.79

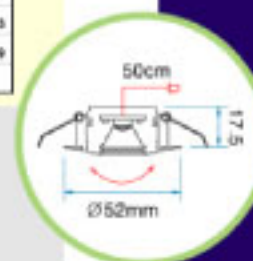

Model: LDL-101DP-2



# LDC - Series

LDC series

Model: LDC-201RDP



## Luxeon LED

Material: Aluminum      Watt: 1W(350mA)  
60x60, H:20mm

IP20   
 15°   
 #53   
 LED COLOR: WH RD BL GN AM W/W   
 COLOR: AB

H(m)	ILL(x)	D(m)
1m	285	0.26
2m	51	0.53
3m	25	0.79

Model: LDC-201DP

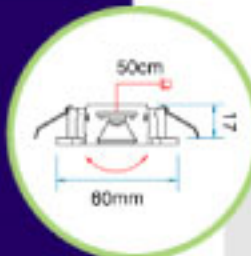

## Luxeon LED

Material: Aluminum      Watt: 1W(350mA)  
60x60, H:20mm

IP20   
 15°   
 #53   
 LED COLOR: WH RD BL GN AM W/W   
 COLOR: AB

H(m)	ILL(x)	D(m)
1m	285	0.26
2m	51	0.53
3m	25	0.79

Model: LDC-202DP

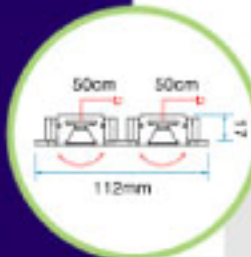

## Luxeon LED

Material: Aluminum      Watt: 1W x 2(350mA)  
60x112, H:20mm

IP20   
 15°   
 63x105   
 LED COLOR: WH RD BL GN AM W/W   
 COLOR: AB

H(m)	ILL(x)	D(m)
1m	285	0.26
2m	51	0.53
3m	25	0.79

Model: LDC-203DP



## Luxeon LED

Material: Aluminum      Watt: 1W x 3(350mA)  
60x164, H:20mm

IP20   
 15°   
 63x157   
 LED COLOR: WH RD BL GN AM W/W   
 COLOR: AB

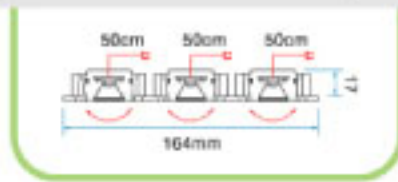

H(m)	ILL(x)	D(m)
1m	285	0.26
2m	51	0.53
3m	25	0.79

Model: LDC-204DP



## Luxeon LED

Material: Aluminum      Watt: 1W x 4(350mA)  
60x216, H:20mm

IP20   
 15°   
 63x209   
 LED COLOR: WH RD BL GN AM W/W   
 COLOR: AB

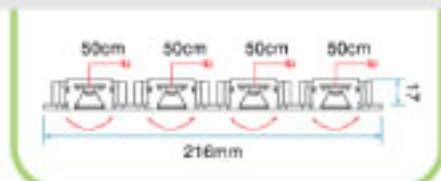

H(m)	ILL(x)	D(m)
1m	285	0.26
2m	51	0.53
3m	25	0.79



### Luxeon LED

Material: Aluminum    Watt: 1W x 5(350mA)  
 60x268, H:20mm



 LED COLOR: WH RD BL GN AM W/W    COLOR: AB

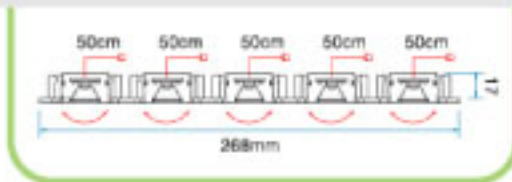

H(m)	E(Lx)	D(m)
1m	205	0.26
2m	51	0.53
3m	23	0.79

Model: LDC-205DP



### Luxeon LED

Material: Aluminum    Watt: 1W x 4(350mA)  
 112x112, H:20mm



 LED COLOR: WH RD BL GN AM W/W    COLOR: AB

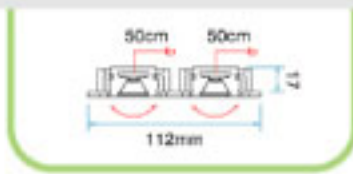

H(m)	E(Lx)	D(m)
1m	205	0.26
2m	51	0.53
3m	23	0.79

Model: LDC-204DPSQ



### Luxeon LED

Material: Aluminum    Watt: 1W x 4(350mA)  
 119x119, H:75mm



 LED COLOR: WH RD BL GN AM W/W    COLOR: AB

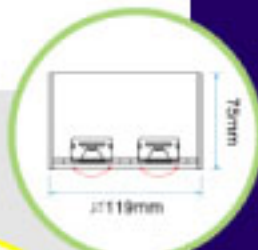

H(m)	E(Lx)	D(m)
1m	205	0.26
2m	51	0.53
3m	23	0.79

Model: LCL-204DPSQ



### Luxeon LED

Material: Aluminum    Watt: 1W x 9(350mA)  
 171x171, H:75mm



 LED COLOR: WH RD BL GN AM W/W    COLOR: AB



H(m)	E(Lx)	D(m)
1m	205	0.26
2m	51	0.53
3m	23	0.79

Model: LCL-209DPSQ



## • *MD series*





# MD - Series

Model: MD-03



## Luxeon LED

Material: Aluminum  
Available for MR-16  
ø50, H:27mm

Watt: 1W x 3(350mA)

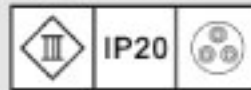

LED COLOR: WH RD BL GN AM W/W

COLOR: AB

H(m)	E(Lx) 2x8°	D(m)
1m	432	0.28
2m	108	0.56
3m	48	0.84
4m	27	1.12

Model: MD-06

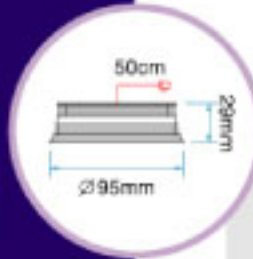

## Luxeon LED

Material: Aluminum  
Available for PAR-30  
ø95, H:29mm

Watt: 1W x 6(350mA)

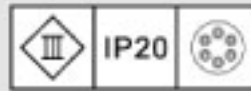

LED COLOR: WH RD BL GN AM W/W

COLOR: AB

H(m)	E(Lx) 2x8°	D(m)
1m	823	0.26
2m	205	0.53
3m	133	0.79
4m	96	1.05

Model: MD-012

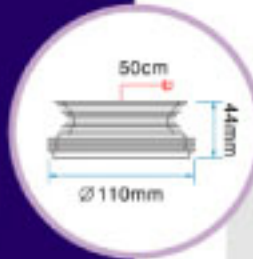

## Luxeon LED

Material: Aluminum  
Available for AR-111  
ø110, H:44mm

Watt: 1W x 12(350mA)

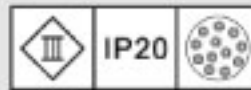

LED COLOR: WH RD BL GN AM W/W

COLOR: AB

H(m)	E(Lx) 2x8°	D(m)
1m	2170	0.26
2m	532	0.53
3m	355	0.79
4m	233	1.05

Model: MD-015

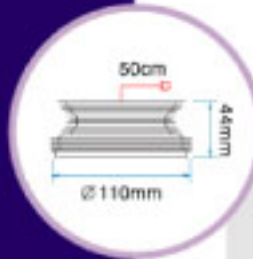

## Luxeon LED

Material: Aluminum  
Available for AR-111  
ø110, H:44mm

Watt: 1W x 15 (350mA)

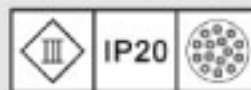

LED COLOR: WH RD BL GN AM W/W

COLOR: AB

H(m)	E(Lx) 2x8°	D(m)
1m	2770	0.26
2m	693	0.53
3m	455	0.79
4m	315	1.05

*LWA series*





# LWA - Series

Model: LWA-2011A

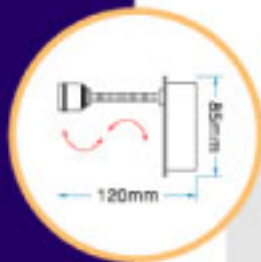

## Luxeon LED

Material: Aluminum/Steel      Watt: 1W(350mA)  
input: 100-240V

LED COLOR:      COLOR:  
 WH  RD  BL  GN  AM  W/W     SV  SC

Luxeon LED 1W 15°		
H(m)	E(Lx)	D(m)
1m	205	0.28
2m	51	0.53
3m	23	0.79

Model: LWA-2011B

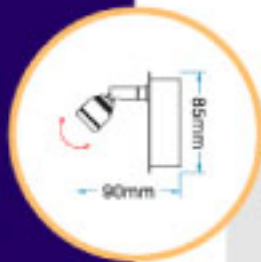

## Luxeon LED

Material: Aluminum/Steel      Watt: 1W(350mA)  
input: 100-240V

LED COLOR:      COLOR:  
 WH  RD  BL  GN  AM  W/W     SV  SC

Luxeon LED 1W 15°		
H(m)	E(Lx)	D(m)
1m	205	0.28
2m	51	0.53
3m	23	0.79

Model: LWA-2012A



## Luxeon LED

Material: Aluminum/Steel      Watt: 1W x 2(350mA)  
input: 100-240V

LED COLOR:      COLOR:  
 WH  RD  BL  GN  AM  W/W     SV  SC

Luxeon LED 1W 15°		
H(m)	E(Lx)	D(m)
1m	205	0.28
2m	51	0.53
3m	23	0.79

Model: LWA-2021A

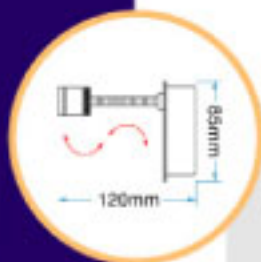

## Luxeon LED

Material: Aluminum/Steel      Watt: 1W(350mA)  
input: 100-240V

LED COLOR:      COLOR:  
 WH  RD  BL  GN  AM  W/W     SV  SC

Luxeon LED 1W 15°		
H(m)	E(Lx)	D(m)
1m	205	0.28
2m	51	0.53
3m	23	0.79

### Luxeon LED

Material: Aluminum/Steel      Watt: 1W(350mA)  
input: 100-240V

LED COLOR:      COLOR:  
 WH  RD  BL  GN  AM  W/W       SV  SC

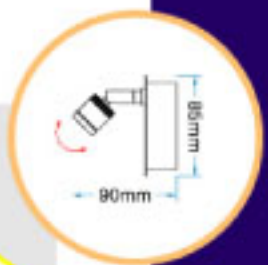
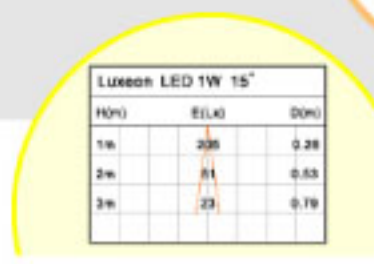

Model: LWA-2021B



### Luxeon LED

Material: Aluminum/Steel      Watt: 1W X 2(350mA)  
input: 100-240V

LED COLOR:      COLOR:  
 WH  RD  BL  GN  AM  W/W       SV  SC

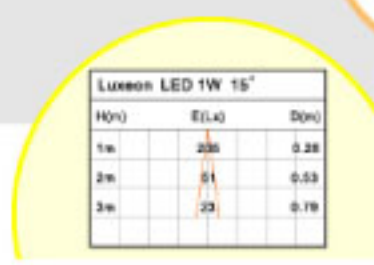

Model: LWA-2022A



### Luxeon LED

Material: Aluminum/Steel      Watt: 1W X 3(350mA)  
input: 100-240V

LED COLOR:      COLOR:  
 WH  RD  BL  GN  AM  W/W       SV  SC

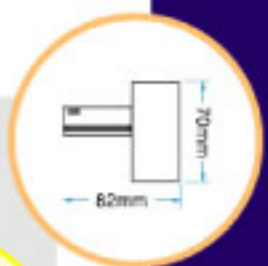
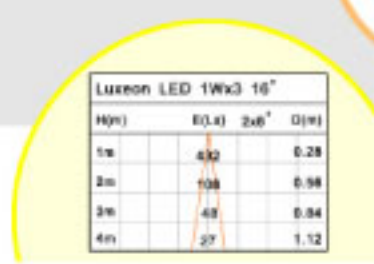

Model: LWA-2511





# LWA - Series

Model: LWA-0103R



## Z-Power LED

Material: Aluminum  
input: 100-240V

Watt: 1.2W x 3(350mA)

LED COLOR:

WH RD BL GN AM W/W

COLOR:

AB

H(m)	ELx(L)	2x25°	D(m)
1m	24		0.83
2m	8		1.86
3m	3		2.80
4m	2		3.73

Model: LWA-0103PR



## Luxeon LED

Material: Aluminum  
input: 100-240V

Watt: 1W x 3(350mA)

LED COLOR:

WH RD BL GN AM W/W

COLOR:

AB

H(m)	ELx(L)	2x25°	D(m)
1m	255		0.26
2m	81		0.83
3m	29		0.79

Model: LWA-0101L

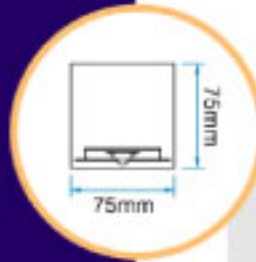

## Z-Power LED

Material: Aluminum  
input: 100-240V

Watt: 1.2W(350mA)

LED COLOR:

WH RD BL GN AM W/W

COLOR:

AB WH BK SV

H(m)	ELx(L)	2x25°	D(m)
1m	24		0.83
2m	8		1.86
3m	3		2.80
4m	2		3.73

Model: LWA-0101PL

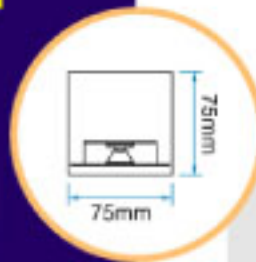

## Luxeon LED

Material: Aluminum  
input: 100-240V

Watt: 1W(350mA)

LED COLOR:

WH RD BL GN AM W/W

COLOR:

AB

H(m)	ELx(L)	2x25°	D(m)
1m	255		0.26
2m	81		0.83
3m	29		0.79



## Z-Power LED

Material: Aluminum      Watt: 1.2W x 2(350mA)  
input: 100-240V

LED COLOR:      COLOR:  
 WH  RD  BL  GN  AM  W/W       AS

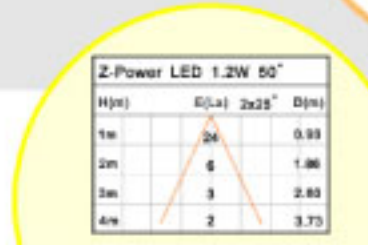
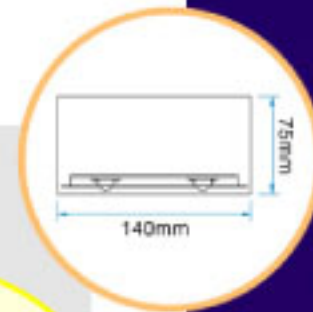

Model: LWA-0102L



## Luxeon LED

Material: Aluminum      Watt: 1W x 2(350mA)  
input: 100-240V

LED COLOR:      COLOR:  
 WH  RD  BL  GN  AM  W/W       AS

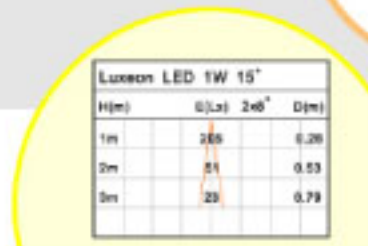
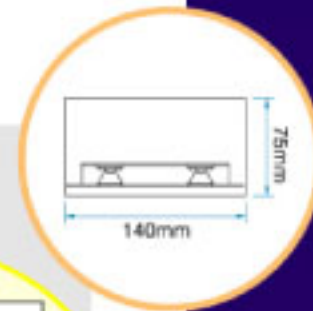

Model: LWA-0102PL



## Z-Power LED

Material: Aluminum      Watt: 1.2W x 3(350mA)  
input: 100-240V

LED COLOR:      COLOR:  
 WH  RD  BL  GN  AM  W/W       AS

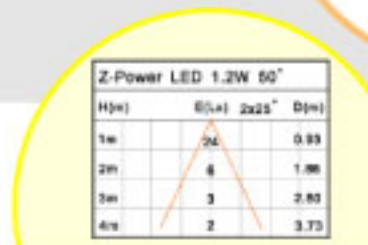
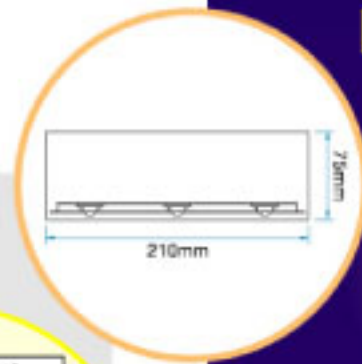

Model: LWA-0103L

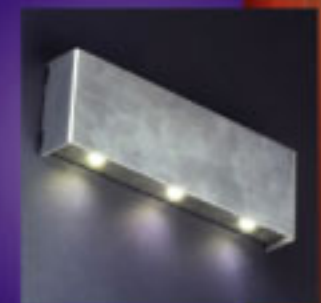

## Luxeon LED

Material: Aluminum      Watt: 1W x 3(350mA)  
input: 100-240V

LED COLOR:      COLOR:  
 WH  RD  BL  GN  AM  W/W       AS

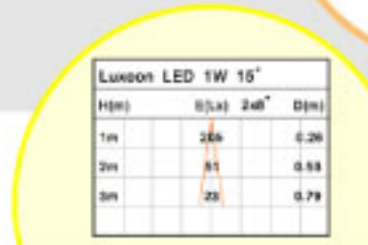
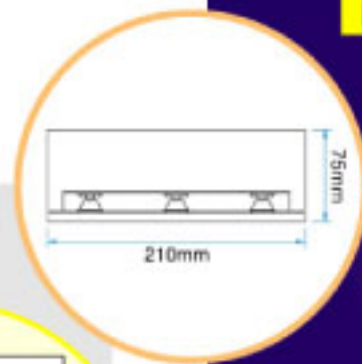

Model: LWA-0103PL





[www.futuraalighting.com](http://www.futuraalighting.com)



# LWA - Series

Model: LWA-102

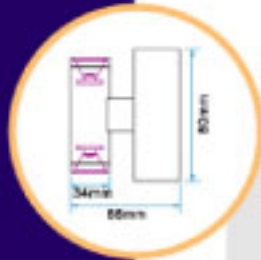

## Luxeon LED

Material: Aluminum  
input: 100-240V

Watt: 1W x 2(350mA)



IP20



LED COLOR:

COLOR:



Luxeon LED 1W 15°			
H(m)	E(Lx) 2x8°	D(m)	
1m	355	0.26	
2m	81	0.53	
3m	29	0.79	

Model: LWA-201

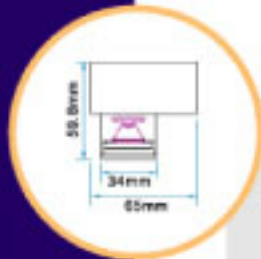

## Luxeon LED

Material: Aluminum  
input: 100-240V

Watt: 1W(350mA)



IP20



LED COLOR:

COLOR:



Luxeon LED 1W 15°			
H(m)	E(Lx) 2x8°	D(m)	
1m	355	0.26	
2m	81	0.53	
3m	29	0.79	

Model: LWA-202

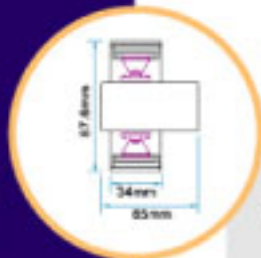

## Luxeon LED

Material: Aluminum  
input: 100-240V

Watt: 1W x 2(350mA)



IP20



LED COLOR:

COLOR:



Luxeon LED 1W 15°			
H(m)	E(Lx) 2x8°	D(m)	
1m	355	0.26	
2m	81	0.53	
3m	29	0.79	



*LDS series*



# LDS - Series

Model: LDS-2011A.300



## Luxeon LED

Material: Aluminum/brass Watt: 1W(350mA)

LED COLOR:

WH RD BL GN AM W/W

COLOR:

SC CH

H(m)	E(Lx)	D(m)
1m	205	0.28
2m	51	0.53
3m	23	0.79

Model: LDS-2012A.300



## Luxeon LED

Material: Aluminum/brass Watt: 1W x 2(350mA)

LED COLOR:

WH RD BL GN AM W/W

COLOR:

SC CH

H(m)	E(Lx)	D(m)
1m	205	0.28
2m	51	0.53
3m	23	0.79

Model: LDS-2011B.300

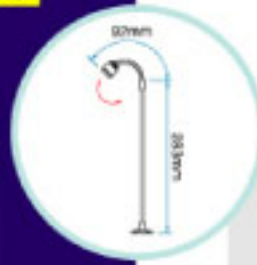

## Luxeon LED

Material: Aluminum/brass Watt: 1W(350mA)

LED COLOR:

WH RD BL GN AM W/W

COLOR:

SC CH

H(m)	E(Lx)	D(m)
1m	205	0.28
2m	51	0.53
3m	23	0.79

Model: LDS-2011C.300



## Luxeon LED

Material: Aluminum/brass Watt: 1W(350mA)

LED COLOR:

WH RD BL GN AM W/W

COLOR:

SC CH

H(m)	E(Lx)	D(m)
1m	205	0.28
2m	51	0.53
3m	23	0.79

LDS series

## Luxeon LED

Material: Aluminum/brass Watt: 1W(350mA)

LED COLOR:

WH RD BL GN AM W/W

COLOR:

SC CH

Luxeon LED 1W 15°		
H(m)	E(Lx)	D(m)
1m	205	0.26
2m	51	0.53
3m	23	0.79

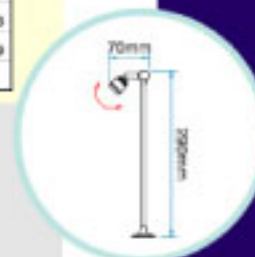

Model: LDS-2011D.300



## Luxeon LED

Material: Aluminum/brass Watt: 1W x 2(350mA)

LED COLOR:

WH RD BL GN AM W/W

COLOR:

SC CH

Luxeon LED 1W 15°		
H(m)	E(Lx)	D(m)
1m	205	0.26
2m	51	0.53
3m	23	0.79

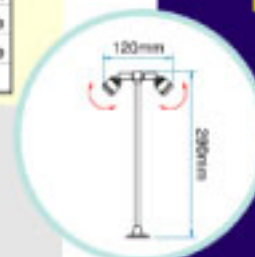

Model: LDS-2012D.300



## Luxeon LED

Material: Aluminum/brass Watt: 1W x 2(350mA)

LED COLOR:

WH RD BL GN AM W/W

COLOR:

SC CH

Luxeon LED 1W 15°		
H(m)	E(Lx)	D(m)
1m	205	0.26
2m	51	0.53
3m	23	0.79

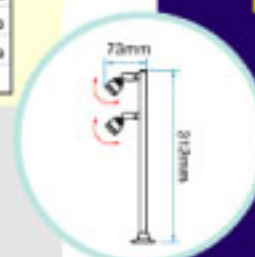

Model: LDS-2012N.300



LDS series



# LDS - Series

Model: LDS-2021A.300



## Luxeon LED

Material: Aluminum/brass Watt: 1W(350mA)

LED COLOR:

WH RD BL GN AM W/W

COLOR:

SC CH

Luxeon LED 1W 15°		
H(m)	E(Lx)	D(m)
1m	355	0.26
2m	81	0.53
3m	29	0.79

Model: LDS-2021B.300



## Luxeon LED

Material: Aluminum/brass Watt: 1W(350mA)

LED COLOR:

WH RD BL GN AM W/W

COLOR:

SC CH

Luxeon LED 1W 15°		
H(m)	E(Lx)	D(m)
1m	355	0.26
2m	81	0.53
3m	29	0.79

Model: LDS-2021C.300



## Luxeon LED

Material: Aluminum/brass Watt: 1W(350mA)

LED COLOR:

WH RD BL GN AM W/W

COLOR:

SC CH

Luxeon LED 1W 15°		
H(m)	E(Lx)	D(m)
1m	355	0.26
2m	81	0.53
3m	29	0.79

Model: LDS-2021D.300

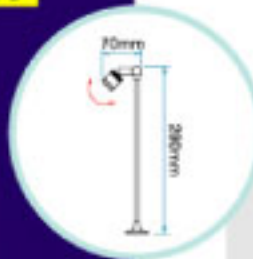

## Luxeon LED

Material: Aluminum/brass Watt: 1W(350mA)

LED COLOR:

WH RD BL GN AM W/W

COLOR:

SC CH

Luxeon LED 1W 15°		
H(m)	E(Lx)	D(m)
1m	355	0.26
2m	81	0.53
3m	29	0.79

## Luxeon LED

Material: Aluminum/brass Watt: 1W x 2(350mA)

LED COLOR:

WH RO BL GN AM W/W

COLOR:

SC CH

H(m)	E(Lx)	D(m)
1m	255	0.26
2m	61	0.53
3m	23	0.79

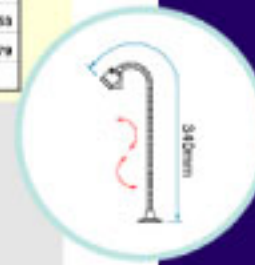

Model: LDS-2022A.300



## Luxeon LED

Material: Aluminum/brass Watt: 1W x 2(350mA)

LED COLOR:

WH RO BL GN AM W/W

COLOR:

SC CH

H(m)	E(Lx)	D(m)
1m	255	0.26
2m	61	0.53
3m	23	0.79

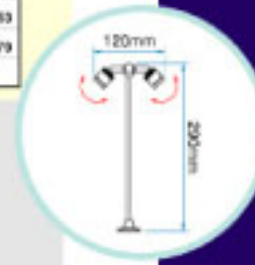

Model: LDS-2022D.300



## Luxeon LED

Material: Aluminum/brass Watt: 1W x 2(350mA)

LED COLOR:

WH RO BL GN AM W/W

COLOR:

SC CH

H(m)	E(Lx)	D(m)
1m	255	0.26
2m	61	0.53
3m	23	0.79

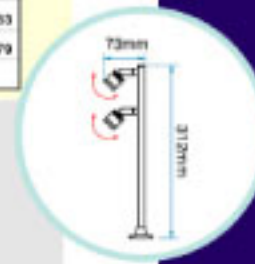

Model: LDS-2022N.300



## Luxeon LED

Material: Aluminum/brass Watt: 1W x 3(350mA)

LED COLOR:

WH RO BL GN AM W/W

COLOR:

SC CH

H(m)	E(Lx)	2xθ°	D(m)
1m	492		0.26
2m	108		0.56
3m	48		0.84
4m	27		1.12

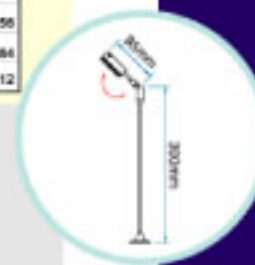

Model: LDS-2511C .300





# LDS - Series

Model: LDS-2511D.300

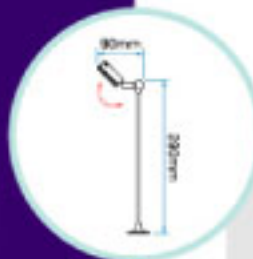

## Luxeon LED

Material: Aluminum/brass Watt: 1W x 3(350mA)

LED COLOR:

WH RD BL GN AM W/W

COLOR:

SC CH

Luxeon LED 1Wx3 18°			
H(m)	E(Lx)	2xθ°	D(m)
1m	432		0.28
2m	108		0.50
3m	48		0.84
4m	27		1.12

Model: LDS-2512D.300

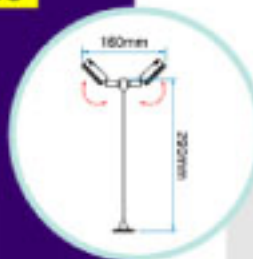

## Luxeon LED

Material: Aluminum/brass Watt: 1W x 6(350mA)

LED COLOR:

WH RD BL GN AM W/W

COLOR:

SC CH

Luxeon LED 1Wx3 18°			
H(m)	E(Lx)	2xθ°	D(m)
1m	432		0.28
2m	108		0.50
3m	48		0.84
4m	27		1.12

Model: LDS-2011W.100

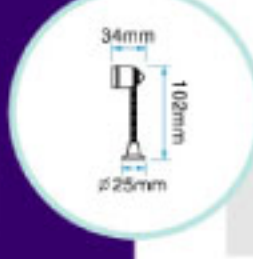

## Luxeon LED

Material: Aluminum/brass Watt: 1W(350mA)

LED COLOR:

WH RD BL GN AM W/W

COLOR:

SC CH

Luxeon LED 1W 15°		
H(m)	E(Lx)	D(m)
1m	265	0.26
2m	65	0.53
3m	29	0.79

Model: LDS-2011W.50



## Luxeon LED

Material: Aluminum/brass Watt: 1W(350mA)

LED COLOR:

WH RD BL GN AM W/W

COLOR:

SC CH

Luxeon LED 1W 15°		
H(m)	E(Lx)	D(m)
1m	265	0.26
2m	65	0.53
3m	29	0.79



### Luxeon LED

Material: Aluminum/brass    Watt: 1W(350mA)

LED COLOR:    COLOR:  
 WH RD BL GN AM W/W    SC CH

H(m)	E(Lx)	D(°)
1m	355	0.26
2m	89	0.53
3m	39	0.79

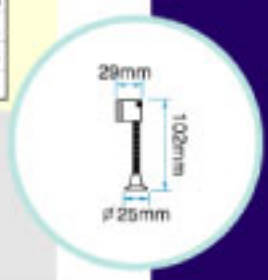

Model: LDS-2021W.100



### Luxeon LED

Material: Aluminum/brass    Watt: 1W(350mA)

LED COLOR:    COLOR:  
 WH RD BL GN AM W/W    SC CH

H(m)	E(Lx)	D(°)
1m	355	0.26
2m	89	0.53
3m	39	0.79



Model: LDS-2021W.50



### Luxeon LED

Material: Aluminum/brass    Watt: 1W x 3(350mA)

LED COLOR:    COLOR:  
 WH RD BL GN AM W/W    SC CH

H(m)	E(Lx)	2xθ(°)	D(°)
1m	432	0.26	
2m	108	0.56	
3m	48	0.84	
4m	27	1.12	

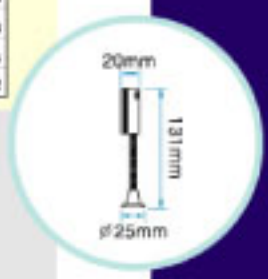

Model: LDS-2511W.100



### Luxeon LED

Material: Aluminum/brass    Watt: 1W x 3(350mA)

LED COLOR:    COLOR:  
 WH RD BL GN AM W/W    SC CH

H(m)	E(Lx)	2xθ(°)	D(°)
1m	432	0.26	
2m	108	0.56	
3m	48	0.84	
4m	27	1.12	

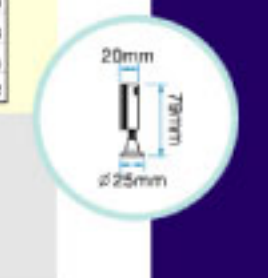

Model: LDS-2511W.50



LDS series



● *LA series* ●

# LA - Series,

Model: LA-102



Model: LA-102-1

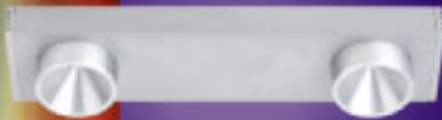

Model: LA-102-2

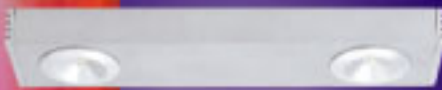

Model: LA-102P



## Z-Power LED

Material: Aluminum      Watt: 1.2W x 2(350mA)  
input: 100~240V

LED COLOR:      COLOR:  
WH RD BL GN AM W/W      AB WH BK SV

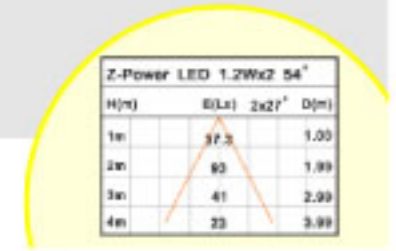

## Z-Power LED

Material: Aluminum      Watt: 1.2W x 2(350mA)  
input: 100~240V

LED COLOR:      COLOR:  
WH RD BL GN AM W/W      AB WH BK SV

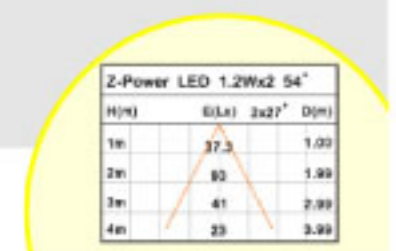

## Z-Power LED

Material: Aluminum      Watt: 1.2W x 2(350mA)  
input: 100~240V

LED COLOR:      COLOR:  
WH RD BL GN AM W/W      AB WH BK SV

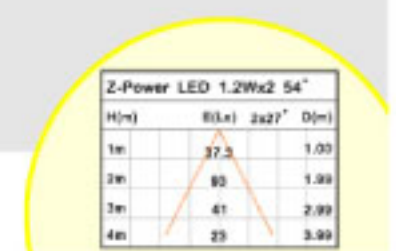

## Luxeon LED

Material: Aluminum      Watt: 1W x 2(350mA)  
input: 100~240V

LED COLOR:      COLOR:  
WH RD BL GN AM W/W      AB WH BK SV

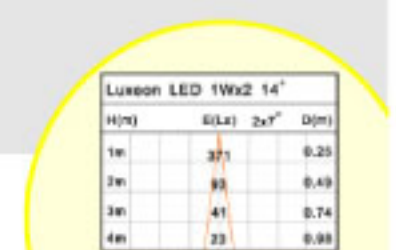

LA series





# Index of Products

<i>LDL series</i>	1.1 - 1.8
<i>LDC series</i>	2.1 - 2.8
<i>MD series</i>	3.1
<i>LWA series</i>	4.1 - 4.5
<i>LDS series</i>	5.1 - 5.6
<i>LA series</i>	6.1 - 6.3
<i>ODL series</i>	7.1 - 7.10
<i>LSP series</i>	8.1 - 8.4
<i>LPT series</i>	9.1 - 9.3
<i>ML series</i>	10.1
<i>Accessories</i>	11.1

### Luxeon LED

Material: Aluminum  
input: 100~240V      Watt: 1W x 2(350mA)

LED COLOR: WH RD BL GN AM W/W      COLOR: AB WH BK SV

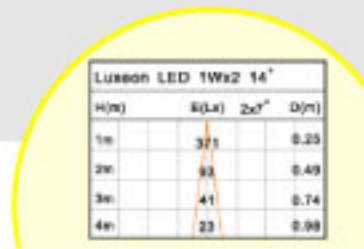

Model: LA-102P-1



### Luxeon LED

Material: Aluminum  
input: 100~240V      Watt: 1W x 2(350mA)

LED COLOR: WH RD BL GN AM W/W      COLOR: AB WH BK SV

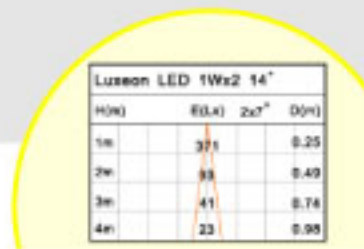

Model: LA-102P-2



### Z-Power LED

Material: Aluminum  
input: 100~240V      Watt: 1.2W x 3(350mA)

LED COLOR: WH RD BL GN AM W/W      COLOR: AB WH BK SV

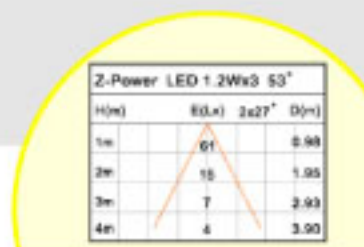
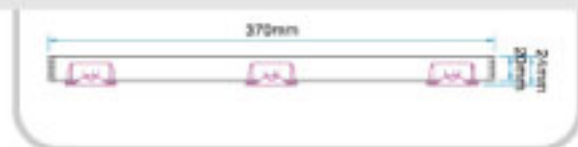

Model: LA-103



### Z-Power LED

Material: Aluminum  
input: 100~240V      Watt: 1.2W x 3(350mA)

LED COLOR: WH RD BL GN AM W/W      COLOR: AB WH BK SV

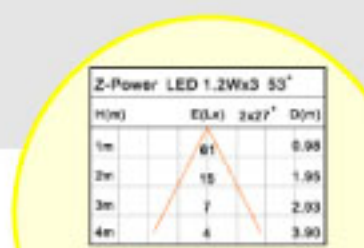
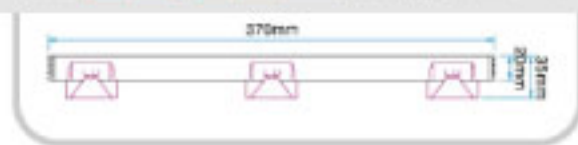

Model: LA-103-1



LA series

# LA - Series

Model: LA-103-2



## Z-Power LED

Material: Aluminum      Watt: 1.2W x 3(350mA)  
input: 100~240V

LED COLOR:      COLOR:  
WH RD BL GN AM W/W      AB WH BK SV

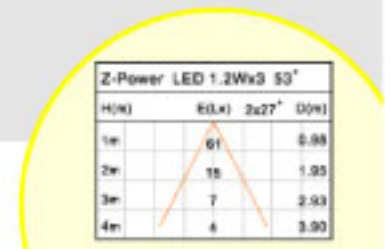
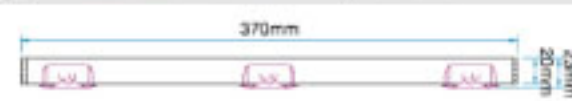

Model: LA-103P



## Luxeon LED

Material: Aluminum      Watt: 1W x 3(350mA)  
input: 100~240V

LED COLOR:      COLOR:  
WH RD BL GN AM W/W      AB WH BK SV

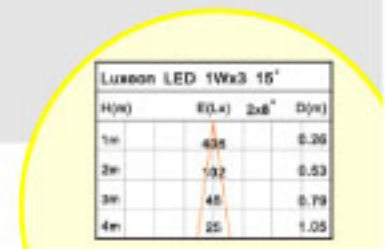
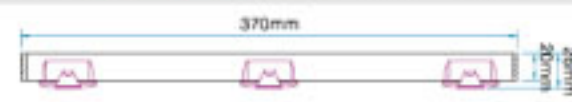

Model: LA-103P-1



## Luxeon LED

Material: Aluminum      Watt: 1W x 3(350mA)  
input: 100~240V

LED COLOR:      COLOR:  
WH RD BL GN AM W/W      AB WH BK SV

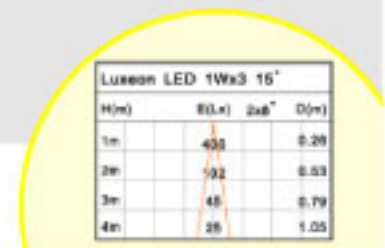

Model: LA-103P-2



## Luxeon LED

Material: Aluminum      Watt: 1W x 3(350mA)  
input: 100~240V

LED COLOR:      COLOR:  
WH RD BL GN AM W/W      AB WH BK SV

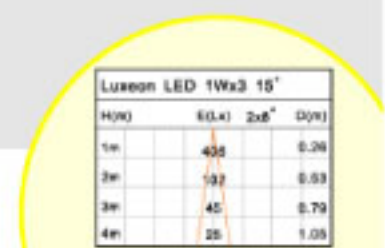





• *ODL series* •

# ODL - Series

Model: ODL-003

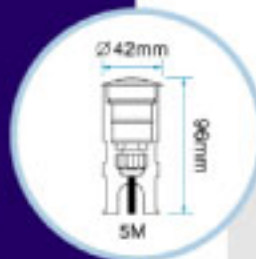

## Z-Power LED

Material: Aluminum or Stainless Steel#316

Watt: 1.2W(350mA)



LED COLOR:



COLOR:



H(m)	6(Lx) 2x23°	0(m)
1m	9	0.85
2m	2.3	1.70
3m	1	2.55
4m	0.5	3.40

IP66

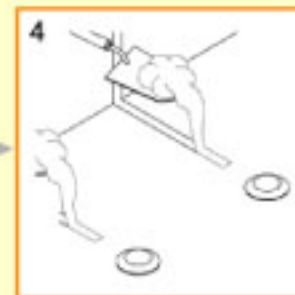
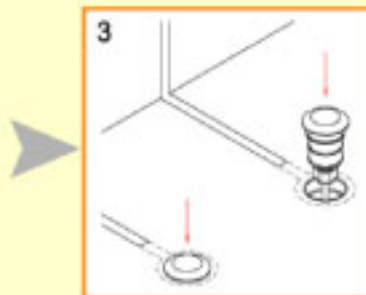
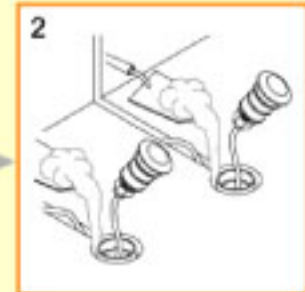
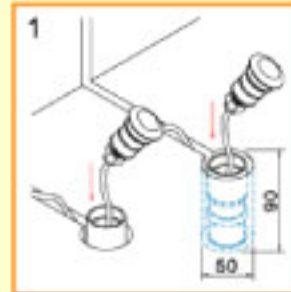
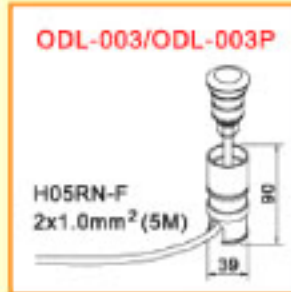

Model: ODL-003P

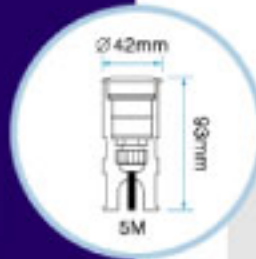

## Luxeon LED

Material: Aluminum or Stainless Steel#316

Watt: 1W(350mA)



LED COLOR:



COLOR:



H(m)	6(Lx) 2x5°	0(m)
1m	10.9	0.28
2m	29.0	0.56
3m	17.7	0.84
4m	9.8	1.12



ODL-003P/BLUE



ODL-003P/GREEN



ODL-003P/WHITE



ODL-003P/AMBER

## Z-Power LED

Material: Aluminum/Nylon Watt: 1.2W(350mA)  
 input: 100~240V



LED COLOR: WH RD BL GN AM | COLOR: WH

H(m)	BS(Lx)	2400°	D(m)
1m	1	1	2.07
2m	1	1	4.14
3m	0.4	1	6.21
4m	0.3	1	8.28



Model: ODL-001



## Z-Power LED

Material: Aluminum/Nylon or Stainless Steel#316 Watt: 1.2W(350mA)  
 input: 100~240V



LED COLOR: WH RD BL GN AM | COLOR: FR

H(m)	BS(Lx)	2400°	D(m)
1m	1	1	2.04
2m	1	1	4.07
3m	0.4	1	6.11
4m	0.3	1	8.14

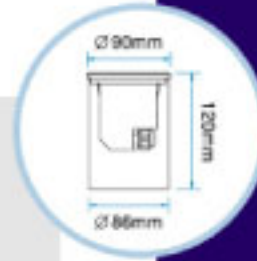

Model: ODL-005



## IP66

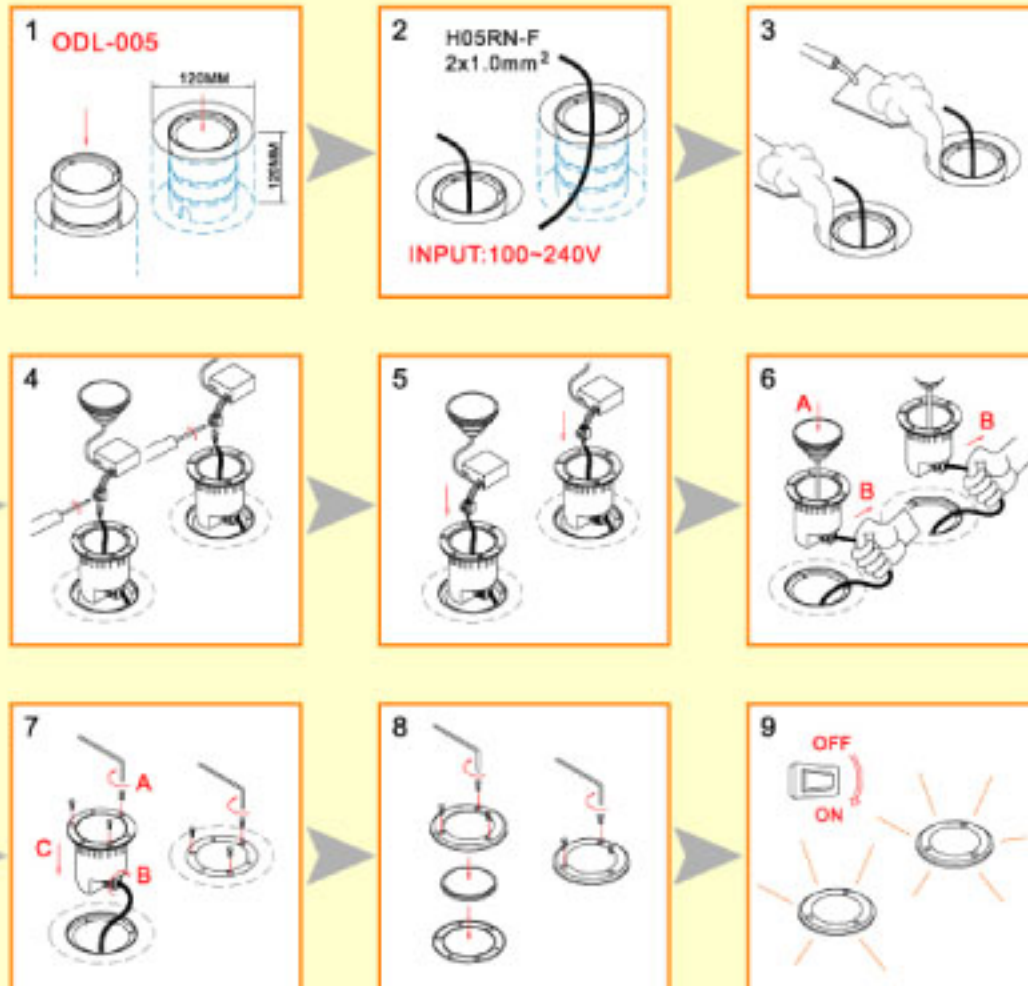

ODL series



# ODL - Series

Model: ODL-107(MD-03)



## MD-03

Material: Stainless Steel#316

Watt: 1W x 3(350mA)



LED COLOR:

WH RD BL GN AM

COLOR:

FR

Luxeon LED 1Wx3 16°			
H(m)	E(Lx) 2x16°	D(m)	
1m	432	0.28	
2m	108	0.56	
3m	48	0.84	
4m	27	1.12	

Model: ODL-107(LED)

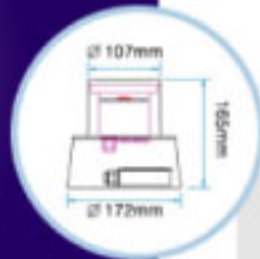

## LED

Material: Stainless Steel#316

Watt: 1.2W(350mA)



LED COLOR:

WH RD BL GN AM

COLOR:

FR

Z-Power LED 1.2W 89°			
H(m)	E(Lx) 2x89°	D(m)	
1m	3	1.87	
2m	0.8	3.83	
3m	0.3	5.90	
4m	0.2	7.88	

Model: ODL-107(MR-16)



## MR-16

Material: Stainless Steel#316

Watt: 12V, 50W



LED COLOR:

WH RD BL GN AM

COLOR:

FR

MR-16 50W 36°			
H(m)	E(Lx) 2x16°	D(m)	
1m	491	0.65	
2m	123	1.30	
3m	55	1.95	
4m	31	2.60	

## MD-03

Material: Stainless Steel#316      Watt: 1W x 3(350mA)

III IP65 | LED COLOR: WH RD BL GN AM | COLOR: FR

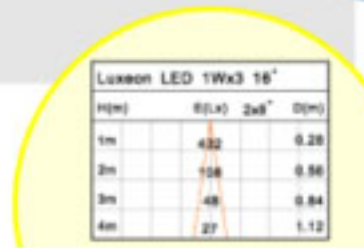
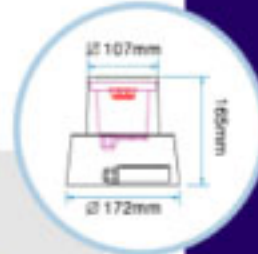

Model: ODL-107SQ(MD-03)



## LED

Material: Stainless Steel#316      Watt: 1.2W(350mA)

III IP65 | LED COLOR: WH RD BL GN AM | COLOR: FR

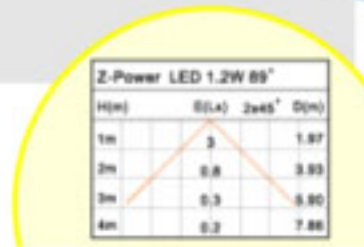
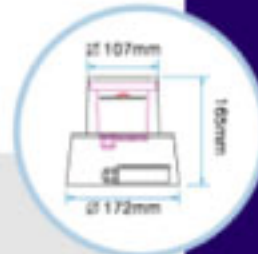

Model: ODL-107SQ(LED)



## MR-16

Material: Stainless Steel#316      Watt: 12V, 50W

III IP65 | LED COLOR: WH RD BL GN AM | COLOR: FR

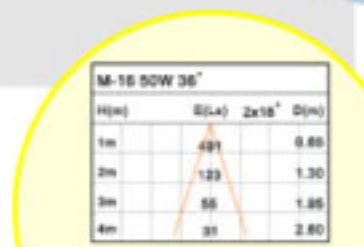
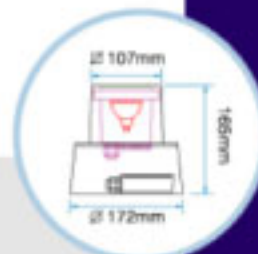

Model: ODL-107SQ(MR-16)





# ODL - Series

Model: ODL-110(MD-03)

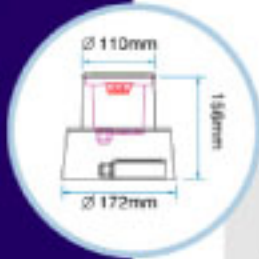

## MD-03

Material: Stainless Steel#316

Watt: 1W x 3(350mA)



IP65

LED COLOR:

WH RD BL GN AM

COLOR:

FR

H(m)	E(Lx)	2x15°	D(m)
1m	432		0.28
2m	108		0.56
3m	48		0.84
4m	27		1.12

Model: ODL-110(LED)

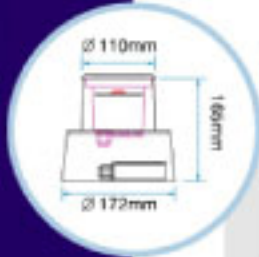

## LED

Material: Stainless Steel#316

Watt: 1.2W(350mA)



IP65

LED COLOR:

WH RD BL GN AM

COLOR:

FR

H(m)	E(Lx)	2x15°	D(m)
1m	2		1.87
2m	0.6		3.93
3m	0.3		5.90
4m	0.2		7.88

Model: ODL-110(MR-16)

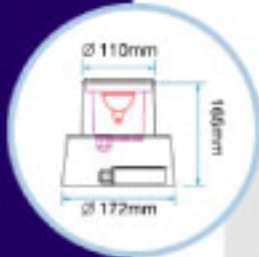

## MR-16

Material: Stainless Steel#316

Watt: 12V, 50W



IP65

LED COLOR:

WH RD BL GN AM

COLOR:

FR

H(m)	E(Lx)	2x15°	D(m)
1m	491		0.65
2m	123		1.30
3m	55		1.95
4m	31		2.60



## MD-03

Material: Stainless Steel#316      Watt: 1W x 3(350mA)



LED COLOR:

WH RD BL GN AM

COLOR:

FR

Luxeon LED 1Wx3 16°			
H(m)	E(Lx)	2x45°	D(m)
1m	432		0.28
2m	108		0.56
3m	48		0.84
4m	27		1.12



**Model: ODL-110SQ(MD-03)**

## LED

Material: Stainless Steel#316      Watt: 1.2W(350mA)



LED COLOR:

WH RD BL GN AM

COLOR:

FR

Z-Power LED 1.2W 89°			
H(m)	E(Lx)	2x45°	D(m)
1m	3		1.97
2m	0.8		3.93
3m	0.3		5.90
4m	0.2		7.86

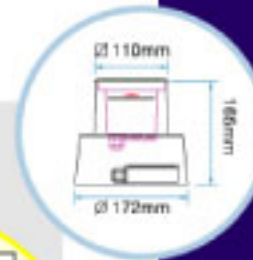

**Model: ODL-110SQ(LED)**

## MR-16

Material: Stainless Steel#316      Watt: 12V, 50W



LED COLOR:

WH RD BL GN AM

COLOR:

FR

MR-16 50W 36°			
H(m)	E(Lx)	2x16°	D(m)
1m	491		0.65
2m	123		1.30
3m	55		1.95
4m	31		2.60

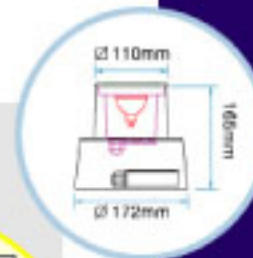

**Model: ODL-110SQ(MR-16)**

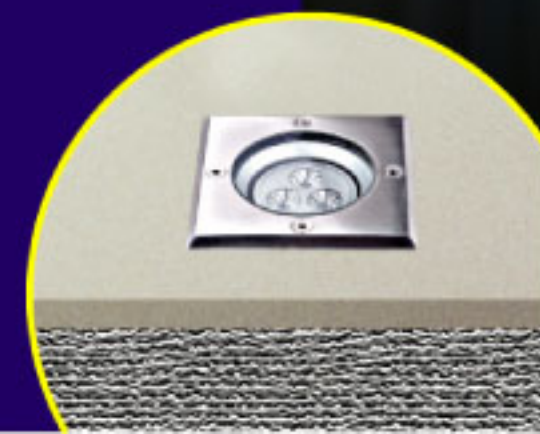

# ODL - Series

Model: ODL-162(MD-12)

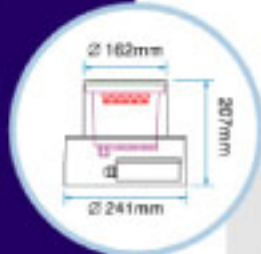

## MD-12

Material: Stainless Steel#316

Watt: 1W x 12(350mA)



IP65

LED COLOR:

WH RD BL GN AM

COLOR:

FR

H(m)	Φ(Lx)	2x10°	Φ(m)
1m	2128		0.26
2m	852		0.53
3m	336		0.79
4m	133		1.05

Model: ODL-162(AR-111)

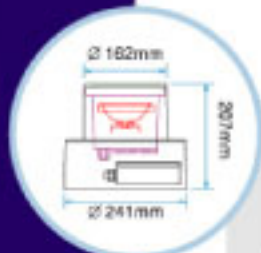

## AR-111

Material: Stainless Steel#316

Watt: 12V, 50W/75W



IP65

LED COLOR:

WH RD BL GN AM

COLOR:

FR

H(m)	Φ(Lx)	2x10°	Φ(m)
1m	1604		0.33
2m	601		0.67
3m	178		1.00
4m	64		1.34

Model: ODL-162SQ(MD-12)

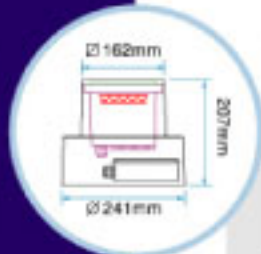

## MD-12

Material: Stainless Steel#316

Watt: 1W x 12(350mA)



IP65

LED COLOR:

WH RD BL GN AM

COLOR:

FR

H(m)	Φ(Lx)	2x10°	Φ(m)
1m	2128		0.26
2m	852		0.53
3m	336		0.79
4m	133		1.05

Model: ODL-162SQ(AR-111)

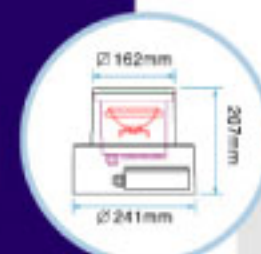

## AR-111

Material: Stainless Steel#316

Watt: 12V,50W/75W



IP65

LED COLOR:

WH RD BL GN AM

COLOR:

FR

H(m)	Φ(Lx)	2x10°	Φ(m)
1m	1604		0.33
2m	601		0.67
3m	178		1.00
4m	64		1.34



# LDL series





### MD-12



Material: Stainless Steel#316  
Watt: 1W x 12(350mA)



LED COLOR:  
WH RD BL GN AM

COLOR:  
FR

H(m)	80(x)	2x10°	D(m)
1m	2728		0.28
2m	632		0.53
3m	236		0.79
4m	130		1.05

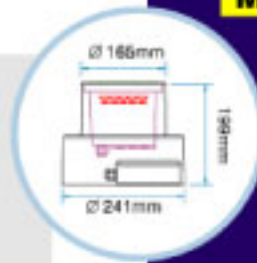

Model: ODL-165(MD-12)



### AR-111

Material: Stainless Steel#316 Watt: 12V, 50W/75W



LED COLOR:  
WH RD BL GN AM

COLOR:  
FR

H(m)	80(x)	2x10°	D(m)
1m	1604		0.33
2m	401		0.67
3m	178		1.00
4m	96		1.34

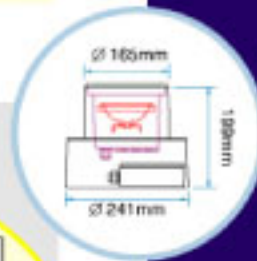

Model: ODL-165(AR-111)



### MD-12

Material: Stainless Steel#316 Watt: 1W x 12(350mA)



LED COLOR:  
WH RD BL GN AM

COLOR:  
FR

H(m)	80(x)	2x10°	D(m)
1m	2728		0.28
2m	632		0.53
3m	236		0.79
4m	130		1.05

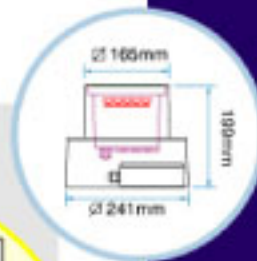

Model: ODL-165SQ(MD-12)



### AR-111

Material: Stainless Steel#316 Watt: 12V, 50W/75W



LED COLOR:  
WH RD BL GN AM

COLOR:  
FR

H(m)	80(x)	2x10°	D(m)
1m	1604		0.33
2m	401		0.67
3m	178		1.00
4m	96		1.34

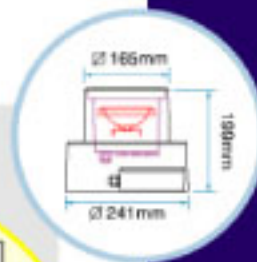

Model: ODL-165SQ(AR-111)

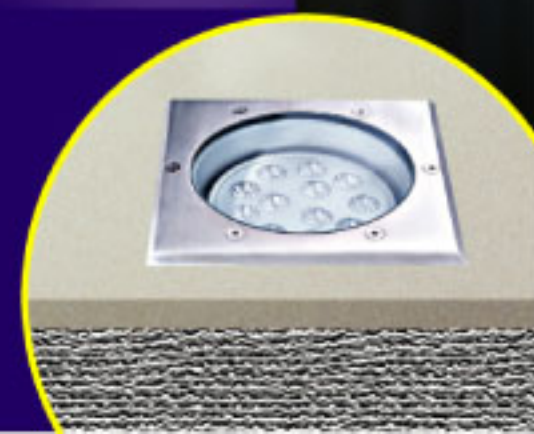

# ODL - Series

Model: ODL-C01/LDL-AC16

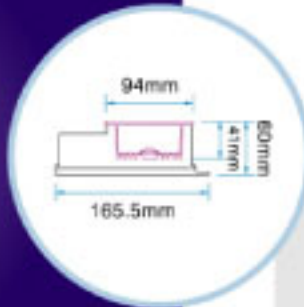
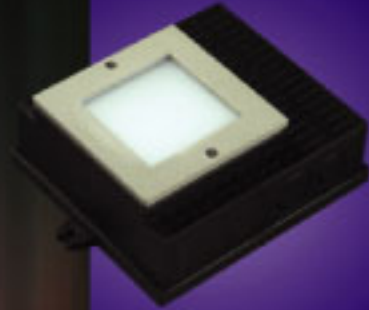

## Z-Power LED

Material: Diecast Aluminum/Nylon Watt: 1.2W(350mA)

IP65 170x170 H:55 | LED COLOR: WH RD BL GN AM W/W | COLOR: WH BK SV

Z-Power LED 1.2W 98°

H(m)	E(Lx) 2x46°	D(m)
1m	3	2.3
2m	0.8	4.6
3m	0.3	6.9
4m	0.2	9.2

Model: ODL-905A/LDL-AC15

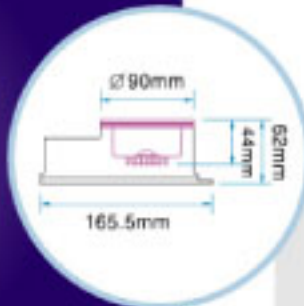
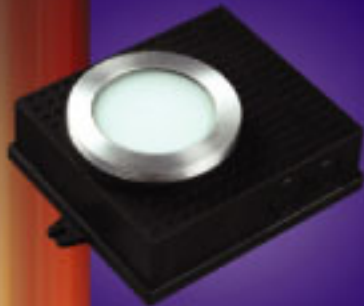

## Z-Power LED

Material: Diecast Aluminum/Nylon Watt: 1.2W(350mA)

IP65 170x170 H:55 | LED COLOR: WH RD BL GN AM W/W | COLOR: AB

Z-Power 1.2W 91°

H(m)	E(Lx) 2x46°	D(m)
1m	3	2.04
2m	0.8	4.07
3m	0.3	6.11

Model: ODL-905A1/LDL-AC15

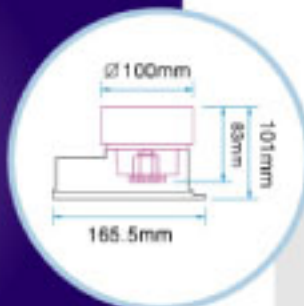

## Z-Power LED

Material: Diecast Aluminum/Nylon Watt: 1.2W(350mA)

IP65 170x170 H:55 | LED COLOR: WH RD BL GN AM W/W | COLOR: FB

Z-Power 1.2W 106°

H(m)	E(Lx) 2x55°	D(m)
1m	3	2.65
2m	0.5	5.31
3m	0.2	7.96

## ACCESSORIES

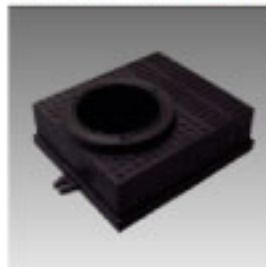





**LDL-AC15**  
Material: Nylon  
IP65  
Available for  
• ODL-905A  
• ODL-905A1



**LDL-AC16**  
Material: Nylon  
IP65  
Available for  
• ODL-C01





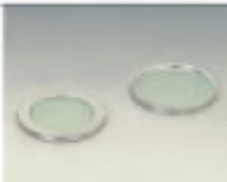







## ODL-905A ACCESSORIES

	<b>DC-AC51</b> Ø90, H:9mm		<b>DC-AC52</b> Ø90, H:20mm
	<b>DC-AC53</b> Ø90, H:20mm		<b>DC-AC54</b> Ø90, H:10mm
	<b>DC-AC55</b> Ø90, H:15mm		<b>DC-AC56</b> Ø90, H:8mm

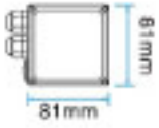
## ODL-905A1 ACCESSORIES

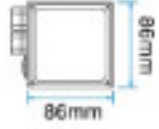
	<b>DC-AC60</b> Ø100, H:46mm		<b>DC-AC61</b> 100x100, H:46mm
	<b>DC-AC63</b> Ø150, H:46mm		<b>DC-AC64</b> 150x150, H:46mm

## ODL-OTBK

	<b>OTBK-H</b>	 27.9mm	 61mm 50.7mm
	<b>OTBK-TRH(81)</b>	 28.9mm	 81mm 81mm
	<b>OTBK-TRH(86)</b>	 27.9mm	 86mm 86mm
	<b>OTBK-TRH(128)</b>	 64mm	 128mm 128mm





• *LSP series* •

# LSP - Series

Model: LSP-1161/HT-303

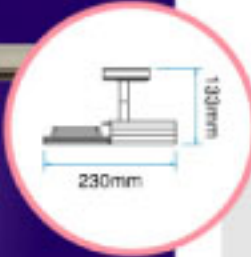

## Luxeon LED

Material: Aluminum  
input: 100~240V

Watt: 1W x 6(350mA)



IP20

DRIVER  
LMVC8A

LED COLOR:

WH RD BL GN AM W/W

COLOR:

WH BK GY SV

H(m)	E(Lx)	2x6°	D(m)
1m	925		0.28
2m	231		0.53
3m	103		0.79
4m	58		1.05

Model: LSP-1162/HT-303

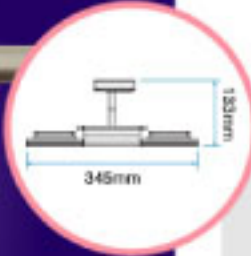

## Luxeon LED

Material: Aluminum  
input: 100~240V

Watt: 1W x 12(350mA)



IP20

DRIVER  
LTVC16A

LED COLOR:

WH RD BL GN AM W/W

COLOR:

WH BK GY SV

H(m)	E(Lx)	2x14°	D(m)
1m	1364		0.40
2m	328		0.80
3m	145		1.24
4m	82		1.62

Model: LSP-1171/HT-303

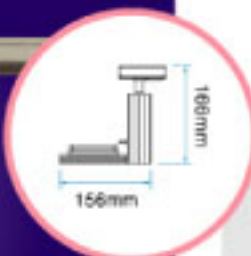

## Luxeon LED

Material: Aluminum  
input: 100~240V

Watt: 1W x 6(350mA)



IP20

DRIVER  
LMVC8A

LED COLOR:

WH RD BL GN AM W/W

COLOR:

WH BK GY SV

H(m)	E(Lx)	2x6°	D(m)
1m	925		0.28
2m	231		0.53
3m	103		0.79
4m	58		1.05

Model: LSP-1172/HT-303

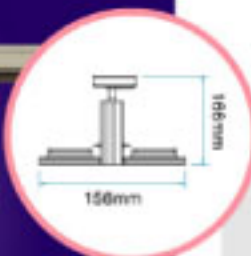

## Luxeon LED

Material: Aluminum  
input: 100~240V

Watt: 1W x 12(350mA)



IP20

DRIVER  
LTVC16A

LED COLOR:

WH RD BL GN AM W/W

COLOR:

WH BK GY SV

H(m)	E(Lx)	2x12°	D(m)
1m	1985		0.41
2m	466		0.81
3m	176		1.22
4m	99		1.63

## Luxeon LED

Material: Aluminum  
 input: 100-240V  
 Watt: 1W x 12(350mA)



IP20



DRIVER  
 LTVC16A

LED COLOR:

WH RD BL GN AM W/W

COLOR:

WH BK GY SV

H(m)	ELx	2x6"	D(%)
1m	1346		0.28
2m	337		0.56
3m	155		0.84
4m	64		1.12

Model: LSP-3002S/HT-303



## Luxeon LED

Material: Aluminum  
 input: 100-240V  
 Watt: 1W x 15(350mA)



IP20



DRIVER  
 LTVC16A

LED COLOR:

WH RD BL GN AM W/W

COLOR:

WH BK GY SV

H(m)	ELx	2x6"	D(%)
1m	1603		0.41
2m	401		0.81
3m	178		1.22
4m	100		1.63

Model: LSP-3002/HT-303



## Luxeon LED

Material: Aluminum  
 input: 100-240V  
 Watt: 1W x 6(350mA)



IP20



DRIVERS  
 LMVC8A

LED COLOR:

WH RD BL GN AM W/W

COLOR:

WH BK GY SV

H(m)	ELx	2x6"	D(%)
1m	920		0.28
2m	231		0.53
3m	103		0.79
4m	58		1.05

Model: LSP-3004/HT-303



LSP series



# LSP - Series

Model: LSP-3006-15/HT-303

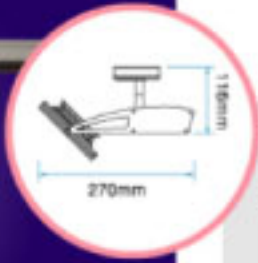

## Luxeon LED

Material: Aluminum  
input: 100~240V

Watt: 1W x 15(350mA)



IP20



LED COLOR:

WH RD BL GN AM W/W

COLOR:

WH BK GY SV

H(m)	ELC(L)	2α(°)	D(m)
1m	2793		0.26
2m	699		0.53
3m	310		0.79
4m	175		1.05

Model: LSP-3006-12/RGB/HT-303

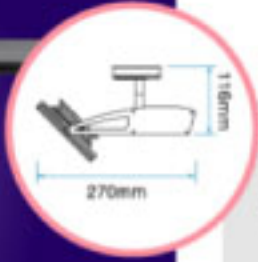

## Luxeon LED

Material: Aluminum  
input: 100~240V

Watt: 1W x 12(350mA)



IP20



LED COLOR:

4 R 4 G 4 B

COLOR:

WH BK GY SV

Model: LSP-303/HT-303

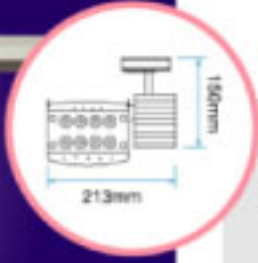

## Luxeon LED

Material: Aluminum  
input: 100~240V

Watt: 1W x 8(350mA)



IP20



LED COLOR:

WH RD BL GN AM W/W

COLOR:

WH BK GY SV

H(m)	ELC(L)	2α(°)	D(m)
1m	595		0.32
2m	148		0.63
3m	96		0.93
4m	57		1.27



## Luxeon LED

Material: Aluminum      Watt: 1W x 16(350mA)  
input: 100~240V

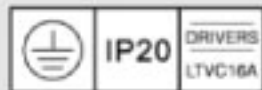

LED COLOR:      COLOR:  
 WH RD BL GN AM W/W      WH BK GY SV

H(m)	E(Lx) 2x16"	D(m)
1m	1288	0.57
2m	322	1.16
3m	143	1.72
4m	81	2.29

Model: LSP-3032/HT-303

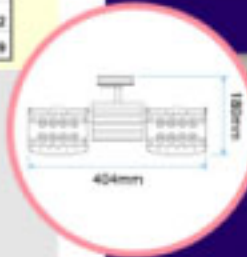

## Luxeon LED

Material: Aluminum      Watt: 3W(700mA)  
input: 12V

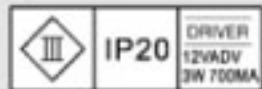

LED COLOR:      COLOR:  
 WH W/W RD BL GN AM      AB

H(m)	E(Lx) 2x7"	D(m)
1m	430	0.25
2m	118	0.49
3m	51	0.74
4m	29	0.98

Model: LCT-2021

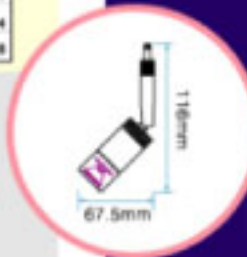

## Luxeon LED

Material: Aluminum/Steel      Watt: 1W x 6(350mA)  
input: 100~240V

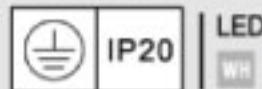

LED COLOR:      COLOR:  
 WH W/W RD BL GN AM      WH BK SV SC SN

H(m)	E(Lx) 2x8"	D(m)
1m	432	0.28
2m	108	0.56
3m	48	0.84
4m	27	1.12

Model: LSP-2512D

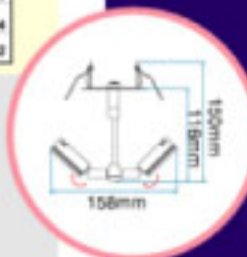

LSP series



● *LPT series* ●



# LPT - Series

Model: LPT-PT111

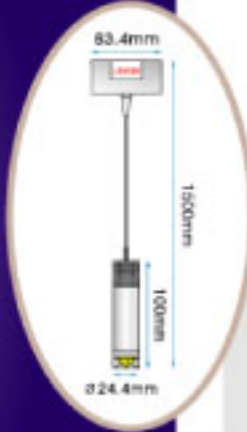

## Z-Power LED

Material: Aluminum      Watt: 1W(350mA)  
input: 100-240V

III	IP20	DRIVER LSVC3A	LED COLOR:					COLOR:
			WH	W/W	RD	BL	GN	AM

Z-Power LED 1.2W 60°

H(m)	E(Lx)	D(m)
1m	24	0.63
2m	6	1.26
3m	3	1.89
4m	2	2.52

Model: LPT-PT111P

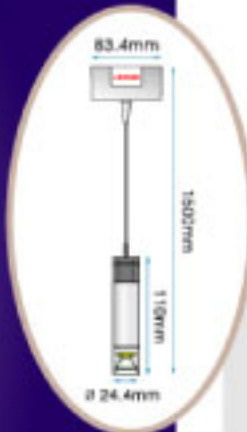

## Luxeon LED

Material: Aluminum      Watt: 1W(350mA)  
input: 100-240V

III	IP20	DRIVER LSVC3A	LED COLOR:					COLOR:
			WH	W/W	RD	BL	GN	AM

Luxeon LED 1W 1.5°

H(m)	E(Lx)	D(m)
1m	365	0.26
2m	91	0.53
3m	38	0.79

Model: LPT-PT113

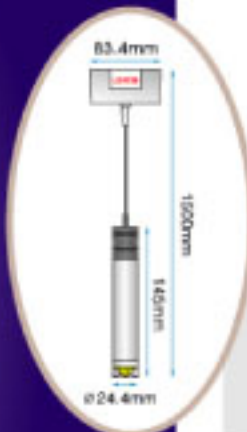

## Z-Power LED

Material: Aluminum      Watt: 2.5W(700mA)  
input: 100-240V

III	IP20	DRIVER LSVC3B	LED COLOR:					COLOR:
			WH	W/W	RD	BL	GN	AM

Luxeon LED 2.5W 60°

H(m)	E(Lx)	D(m)
1m	67	1.15
2m	17	2.31
3m	9	3.48
4m	6	4.62

# LDL - Series

**Model: LDL-C01**

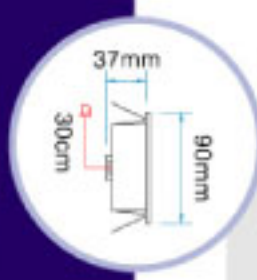

## Z-Power LED

Material: Diecast Aluminum      Watt: 1.2W(350mA)  
90x90, H:40mm

IP20 | LED COLOR: WH RD BL GN AM | COLOR: WH BK SY

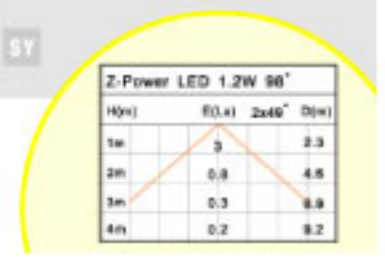

**Model: LDL-D01**

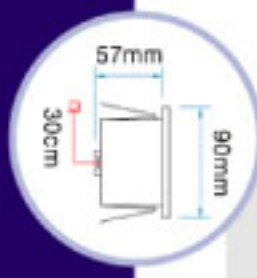

## Z-Power LED

Material: Diecast Aluminum      Watt: 1.2W(350mA)  
90x90, H:60mm

IP20 | LED COLOR: WH RD BL GN AM | COLOR: WH BK SY

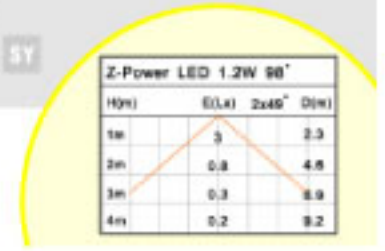

LDL-ACP1    LDL-ACP2    LDL-ACP3    LDL-ACP4    LDL-ACP5    LDL-ACP6    LDL-ACP7

**Model: LDL-G01**

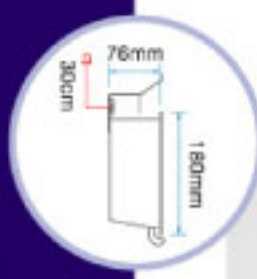

## Piranha LED

Material: Diecast Aluminum / Steel      Watt: 1W(350mA)  
90x180, H:80mm

IP20 | LED COLOR: WH RD BL GN AM | COLOR: WH BK SY

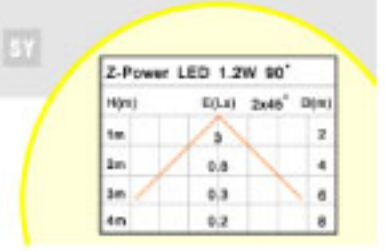

## Luxeon LED

Material: Aluminum      Watt: 3W(700mA)  
input: 100~240V

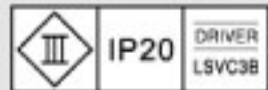

LED COLOR:      COLOR:  
WH W/W RD BL GN AM AB

H(m)	BS(Lx)	2x7°	D(m)
1m	480		0.25
2m	119		0.49
3m	51		0.74
4m	29		0.98

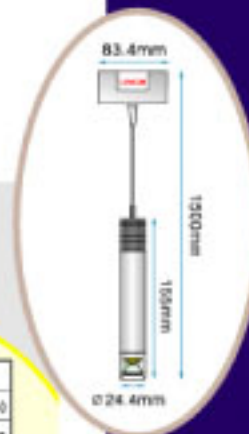

Model: LPT-PT113P



## Z-Power LED

Material: Aluminum/brass      Watt: 1W(350mA)  
input: 12V

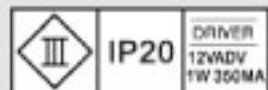

LED COLOR:      COLOR:  
WH W/W RD BL GN AM AB

H(m)	BS(Lx)	50°	D(m)
1m	24		0.93
2m	6		1.86
3m	3		2.80
4m	2		3.73

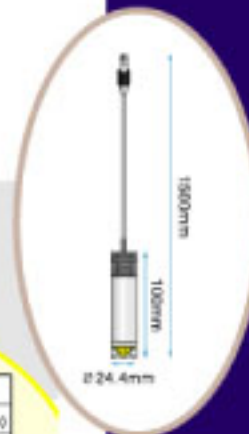

Model: LPT-CT111



## Luxeon LED

Material: Aluminum/brass      Watt: 1W(350mA)  
input: 12V

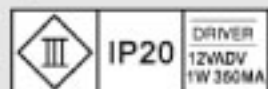

LED COLOR:      COLOR:  
WH W/W RD BL GN AM AB

H(m)	BS(Lx)	15°	D(m)
1m	265		0.28
2m	67		0.53
3m	29		0.79



Model: LPT-CT111P





# LPT - Series

Model: LPT-CT113

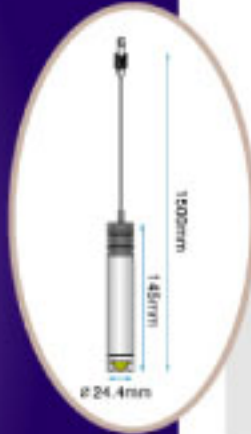

## Z-Power LED

Material: Aluminum/brass  
input: 12V

Watt: 2.5W(700mA)



IP20



LED COLOR:



COLOR:



H(m)	θ(Lx)	2xθ°	Φ(m)
1m	57		1.18
2m	14		2.31
3m	9		3.46
4m	4		4.82

Model: LPT-CT113P

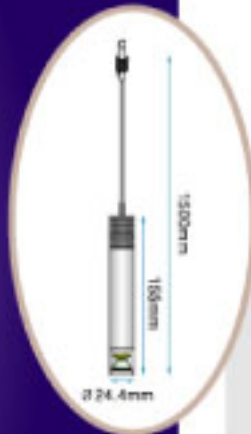

## Luxeon LED

Material: Aluminum/brass  
input: 12V

Watt: 2.5W(700mA)



IP20



LED COLOR:



COLOR:



H(m)	θ(Lx)	2xθ°	Φ(m)
1m	480		0.25
2m	115		0.49
3m	51		0.74
4m	29		0.98



# ML - Series

Model: ML-03



## Luxeon LED

Material: Aluminum  
ø68mm, H:35.5mm

Watt: 1W x 3(350mA)

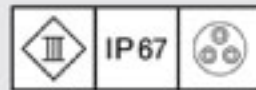

LED COLOR:  
WH RD BL GN AM W/W

COLOR:  
AB WH

Luxeon LED 1Wx3 16°			
H(m)	E(Lx)	2xθ°	D(m)
1m	432		0.28
2m	108		0.56
3m	48		0.84
4m	27		1.12

Model: ML-06

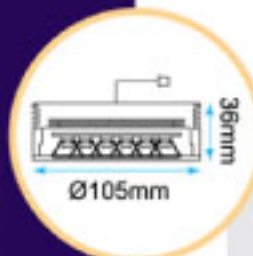

## Luxeon LED

Material: Aluminum  
ø105mm, H:36mm

Watt: 1W x 6(350mA)

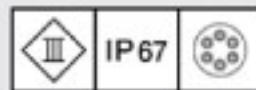

LED COLOR:  
WH RD BL GN AM W/W

COLOR:  
AB WH

Luxeon LED 1Wx6 15°			
H(m)	E(Lx)	2xθ°	D(m)
1m	603		0.26
2m	151		0.53
3m	103		0.79
4m	58		1.05





# Driver Accessories

	<b>LUXEON LED</b>	Watt: 1W
	<b>LUXEON LED</b>	Watt: 1W
	<b>Z-POWER LED</b>	Watt: 1.2W
	<b>Z-POWER LED</b>	Watt: 1.2W
	<b>Z-POWER LED</b>	Watt: 2.5W

LED COLOR:



**LSVC3A**  
**LSVC3AZ**  
100-240V  
MAX: 1Wx3(350A)

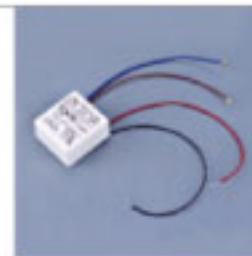

**LSVC3AP**  
100-240V  
MAX: 1Wx3(350A)



**LFVC4AZ**  
100-240V  
MAX: 1Wx4(350A)



**LMVC8A**  
100-240V  
MAX: 1Wx8(350A)  
**LDL-AC3**  
Close-loop plug



**LRVC9A**  
100-240V  
MAX: 1Wx9(350A)



**LLVC12A**  
100-240V  
MAX: 1Wx12(350A)



**LSVC18A**  
100-240V  
MAX: 1Wx18(350A)



**LSVC18AZ**  
100-240V  
MAX: 1Wx18(350A)



**LDL-AC1-6**  
Available for ODL-003



**LDL-AC2**  
Multi-lamp extension  
cord 1007#2awg,  
L:1M/1.5M/2M/3M



**LDL-AC2-3**  
Multi-lamp extension  
cord 1007#2awg,  
L:1M/1.5M/2M/3M



**LDL-AC2-6**  
Multi-lamp extension  
cord 1007#2awg,  
L:1M/1.5M/2M/3M



FUTURA LIGHTING INC.

3305 SW 11TH AVENUE, FORT LAUDERDALE, FL 33315 UNITED STATES.

PHONE: +1 (954) 523 8400, FAX: +1 (954) 523 8600

E-Mail: [admin@futralighting.com](mailto:admin@futralighting.com)

[www.futralighting.com](http://www.futralighting.com)

## Z-Power LED

Material: Diecast Aluminum / Steel Watt: 1.2W(350mA)  
 90x90, H:40mm



**LED COLOR:** WH RD BL GN AM | **COLOR:** WH BK SY

Z-Power LED 1.2W 72°

H(m)	8(Lx)	2x30°	0(W)
1m	8		1.45
2m	2.3		2.91
3m	1		4.38
4m	0.6		5.81



Model: LDL-E01

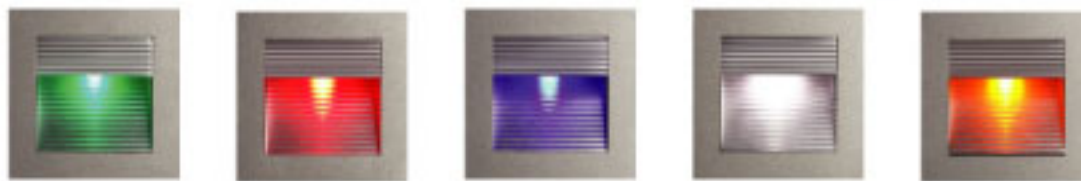
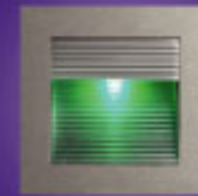

## ACCESSORIES



**AC-C01-HS1**

MATERIAL: STEEL  
 Available for  
 LDL-C01 • LDL-E01 • LDL-D01

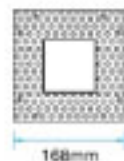

**AC-C01-HS2**

MATERIAL: STEEL  
 Available for  
 LDL-C01 • LDL-E01 • LDL-D01



**AC-C01-HS3**

MATERIAL: STEEL  
 Available for  
 LDL-C01 • LDL-E01



**AC-C01-HS4**

MATERIAL: NYLON  
 Available for  
 LDL-C01 • LDL-E01 • LDL-D01



Model: LDL-E02



## Z-Power LED

Material: Diecast Aluminum / Steel Watt: 1.2W(350mA)  
 90x90, H:80mm



**LED COLOR:** WH RD BL GN AM | **COLOR:** WH BK SY

OSRAM LED 1.2W 40°

H(m)	8(Lx)	2x20°	0(W)
1m	16		0.73
2m	4		1.48
3m	2		2.18
4m	1		2.91

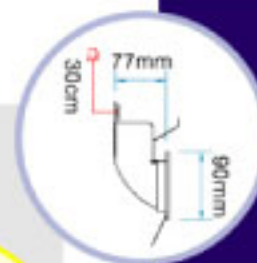



# LDL - Series,

Model: LDL-E03

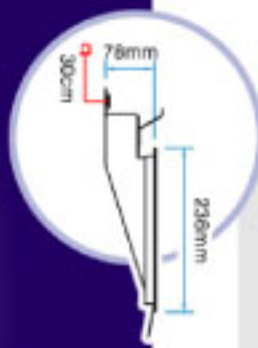

## Luxeon LED

Material: Steel  
90x236, H:80mm

Watt: 1W(350mA)

IP20

LED COLOR: WH RD BL GN AM

COLOR: WH BK SY

OSRAM LED 1.2W 36°

H(m)	E(Ix) lx	2x18°	30°
1m	5	0.63	
2m	5	1.26	
3m	2	1.89	
4m	1	2.51	

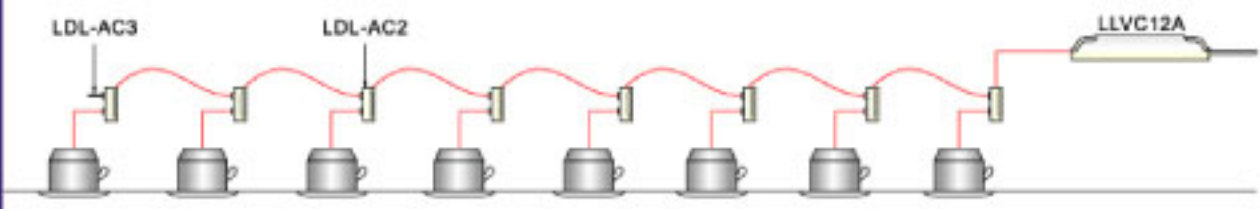

Model: LDL-P01S



## Z-Power LED

Material: Nylon / Diecast Aluminum Watt: 1.2W(350mA)  
42x42, H:53mm

IP20

LED COLOR: WH RD BL GN AM

COLOR: WH BK SY

Z-Power LED 1.2W 41°

H(m)	E(Ix) lx	2x21°	30°
1m	5	0.75	
2m	1.5	1.50	
3m	0.7	2.24	
4m	0.4	2.99	

Model: LDL-P01



## Z-Power LED

Material: Nylon / Diecast Aluminum Watt: 1.2W(350mA)  
ø42, H:53mm

IP20

LED COLOR: WH RD BL GN AM

COLOR: WH BK SY

Z-Power LED 1.2W 45°

H(m)	E(Ix) lx	2x23°	30°
1m	5	0.83	
2m	1.5	1.66	
3m	0.7	2.49	
4m	0.4	3.31	

### Z-Power LED

Material: Aluminum or Stainless Steel#316    Watt: 1.2W(350mA)  
ø42, H:48mm



 LED COLOR: WH RD BL GN AM    COLOR: FR SY

H(m)	8(Lx) 2x23°	0(m)
1m	0	0.86
2m	2.3	1.70
3m	1	2.58
4m	0.8	3.40

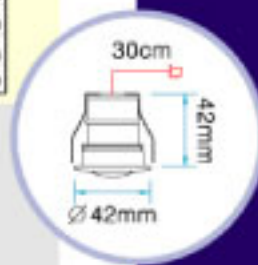

Model: LDL-003

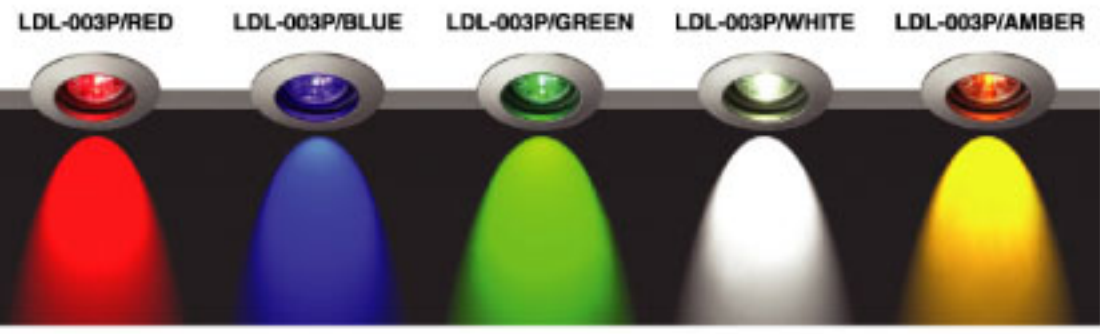

### Luxeon LED

Material: Aluminum or Stainless Steel#316    Watt: 1W(350mA)  
ø42, H:45mm



 LED COLOR: WH RD BL GN AM    COLOR: FR SY

H(m)	8(Lx) 2x8°	0(m)
1m	10.9	0.28
2m	20.8	0.56
3m	17.7	0.84
4m	8.8	1.12



Model: LDL-003P



### Z-Power LED

Material: Diecast Aluminum    Watt: 1.2W(350mA)  
ø42, H:53mm



 LED COLOR: WH RD BL GN AM    COLOR: WH BK SY

H(m)	8(Lx) 2x55°	0(m)
1m	1	2.43
2m	0.3	4.80
3m	0.1	7.28

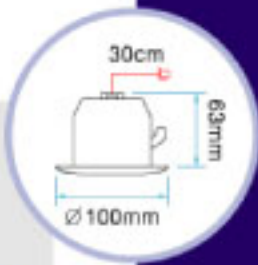

Model: LDL-506

